

Vision systems
area, blemish, match
IVUTGPW04

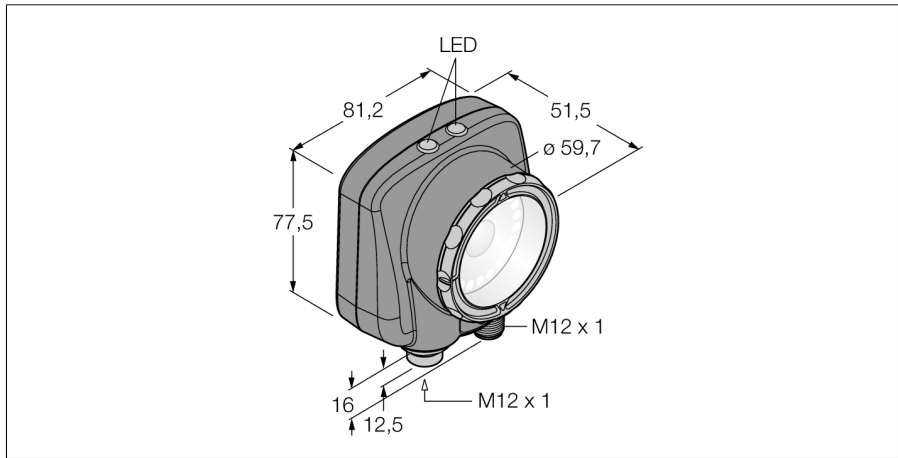

- 1/3" CMOS, 752x480 pixels
- Integrated ring light: white
- Protection class IP67
- External strobe output + 5 VDC
- External trigger input
- Lens, 4.3mm, M12x1
- Display: Integrated 65.5 mm LCD color display, 320 x 240 transreflective
- Operating voltage: 10...30 VDC
- M12 x 1 male, 8-pole
- 2 x PNP switching output
- USB-2.0 host: M12 x 1 male, 8-pole

Type code	IVUTGPW04
Ident no.	3010945
Design	rectangular, iVu
Dimensions	51.5 x 81.2 x 95.3 mm
Housing material	plastic, PBT
Window material	Acrylic, clear
Connection	male, M12 x 1, 8-wire
Protection class	IP67
Ambient temperature	0...+50 °C
Power on display	LED, green
Switching state	LED green
Error indication	LED red
Operating voltage	10...30VDC
DC rated operational current	≤ 500 mA
Short-circuit protection	yes/ cyclic
Reverse polarity protection	yes
Switch element function	NO contact, PNP
Output current	≥ 150 mA
Operating mode	gray value
Bildsensor	CMOS
Auflösung	752 x 480 Pixel
Bildfrequenz	100 fps
Light type	white
Brennweite	4.3 mm

Wiring diagram

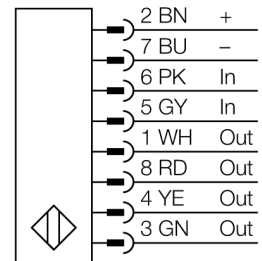

Functional principle

Sensor with 3 integrated operation modes:

1. Pattern recognition, checks if a pattern on a target is identical to the reference pattern.
2. BLOB recognition, for recognition of one or more features.
3. BLOB and location tool for motion control.

Sensor configuration via PC is not required!
Transmission of log files and firmware updates via USB interface.



Selecting the focal length

With known object size or scan field the matching vision sensor is found simply by determining the ratio between the sensing range and the focal length. Use the graphics for selection. Here, the sensing ranges are put in relation to the field view and the lens focal length.

Accessories

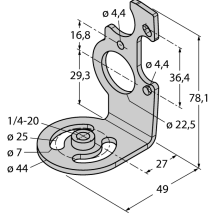
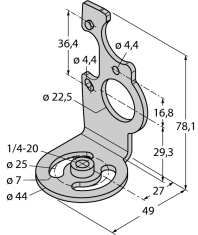
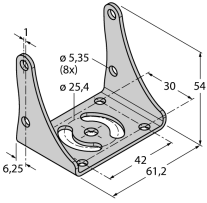
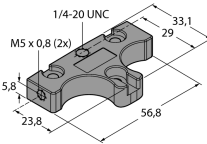
Type code	Ident no.	Description	Dimension drawing
SMBIVURAR	3082547	Brackets for mounting on right side	
SMBIVURAL	3082546	Brackets for mounting on left side	
SMBIVUU	3082549	U-bracket for base mounting (incl. SMBIVUB baseplate)	
SMBIVUB	3082548	Baseplate to extend the installation	

Wiring accessories

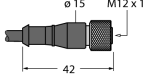
Type code	Ident no.	Description	Dimension drawing
MQDC2S-806	3070975	Connection cable 1.83 m, PVC, female M12 x 1, 8-pin, black	
MQDC2S-806RA	3054616	Connection cable 1.83 m, PVC, female M12 x 1, angled, 8-pin, black	

Wiring accessories

Type code	Ident no.	Description	Dimension drawing
MQDEC-801-USB	3081158	USB adapter cable, M12x1 male, 8-pole, 0.3m	