

530S, 530SN, 530U, 530UN, 530Du, 530DuN, 530US, 530DuS, 530Bp, 530BpN, 530En and 530EnN Pumps

500 series Watson-Marlow Pumps

FEATURES AND BENEFITS

- Colour display and intuitive menu structures provide visual status indication and minimal key presses
- Flow rates from 0.004 ml/min (0.0006 USGPH) to 3.5 L/min (55.48 USGPH)
- 520REM, 520R, 520R2, 520REH, 520REL and 505L pumpheads available as standard, others available on request
- 2200:1 speed control range from 0.1 to 220rpm in 0.1rpm increments
- Keypad incorporates 3-level security PIN lock
- IP31 (NEMA 2) and IP66 (NEMA 4X) cased pumps
- Dual voltage, 115V/230V 50/60Hz
- Remote Analogue/Digital, RS232, RS485, PROFIBUS, SCADA and EtherNet/IP™ control options



Watson-Marlow... Innovation in Full Flow

PERFORMANCE: 520R/R2—TWIN SPRUNG ROLLER PUMPHEAD FOR CONTINUOUS TUBING

- R—Pumphead for continuous 1.6mm wall tubing
- R2—Pumphead for continuous 2.4mm wall tubing



Tube bore and flow rates—ml/min (USGPH)—520R								
Tube material	Speed	0.5mm	1.6mm	3.2mm	4.8mm	6.4mm	8.0mm	9.6mm
Pumpsil®, Neoprene GORE® STA-PURE® Pump Tubing - Series PCS, GORE® STA-PURE® Pump Tubing - Series PFL	0.1-220rpm	0.004-9.5 (0-0.15)	0.04-97 (0-1.54)	0.18-390 (0-6.18)	0.40-870 (0.01-13.8)	0.70-1500 (0.01-23.8)	1.10-2400 (0.02-38)	NA
Marprene®, Bioprene®, PureWeld XL®	0.1-220rpm	0.004-9.0 (0-0.14)	0.04-92 (0-1.46)	0.17-370 (0-5.86)	0.38-830 (0-13.2)	0.67-1500 (0.01-23.8)	1.10-2300 (0.02-36.5)	NA

Tube bore and flow rates—ml/min (USGPH)—520R2								
Tube material	Speed	0.5mm	1.6mm	3.2mm	4.8mm	6.4mm	8.0mm	9.6mm
Pumpsil® GORE® STA-PURE® Pump Tubing - Series PCS GORE® STA-PURE® Pump Tubing - Series PFL	0.1-220rpm	NA	0.04-97 (0-1.54)	0.18-390 (0-6.18)	0.40-870 (0.01-13.8)	0.70-1500 (0.01-23.8)	1.10-2400 (0.02-38)	1.60-3500 (0.03-55.5)
Marprene®/Bioprene®, PureWeld XL®	0.1-220rpm	NA	0.04-92 (0-1.46)	0.17-370 (0-5.86)	0.38-830 (0-13.2)	0.67-1500 (0.01-23.8)	1.10-2300 (0.02-36.5)	1.50-3300 (0.02-52.3)

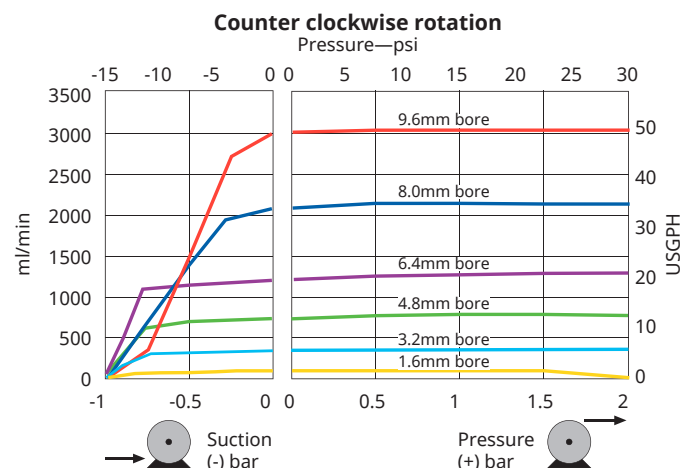
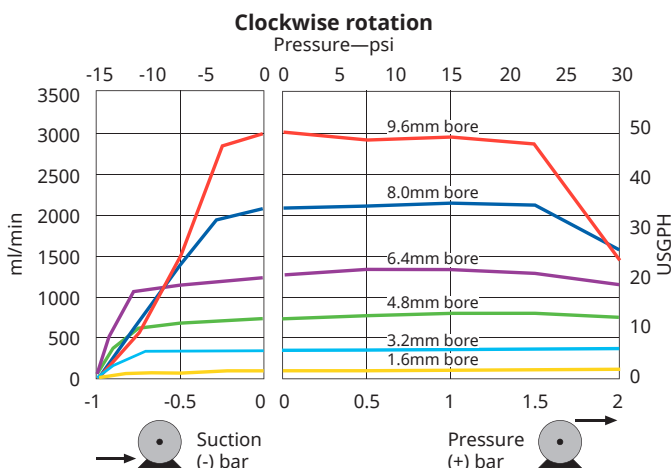

PERFORMANCE: 520REL—TWIN ROLLER PUMPHEAD FOR LOADSURE ELEMENTS

- REL—LoadSure elements for 0–2 bar operation
- LoadSure elements for use with quick release industrial or sanitary tri-clamp connections



LoadSure® element tubing flow rates—ml/min (USGPH)

Tube material	Speed	3.2mm	6.4mm	9.6mm
Pumpsil®, GORE® STA-PURE® Pump Tubing – Series PCS, GORE® STA-PURE® Pump Tubing – Series PFL, Neoprene	0.1-220rpm	0.18–390 (0–6.18)	0.70–1500 (0.01–23.8)	1.60–3500 (0.03–55.5)
Marprene® TL, Bioprene® TL	0.1-220rpm	0.17–370 (0–5.86)	0.67–1500 (0.01–23.8)	1.50–3300 (0.02–52.3)

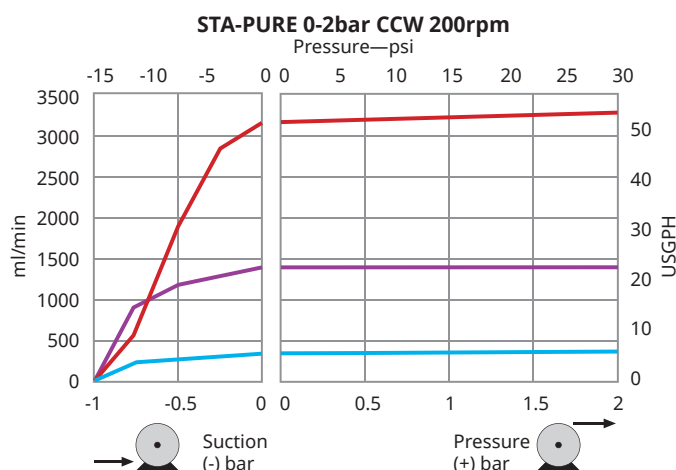
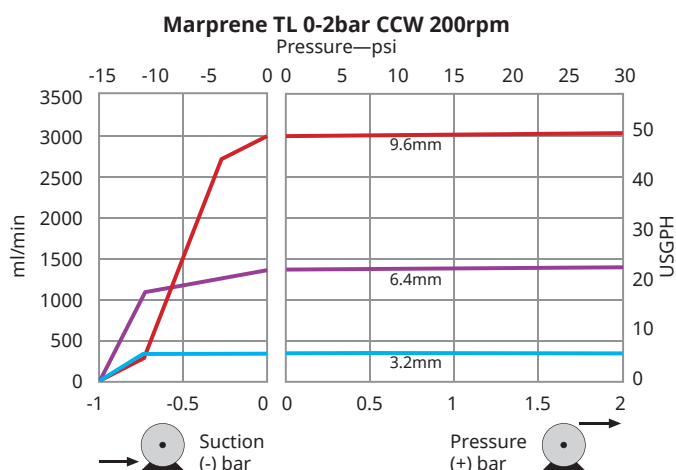

PERFORMANCE: 520REM—TWIN ROLLER PUMPHEAD FOR LOADSURE ELEMENTS

- REM—LoadSure Elements for 2–4 bar operation
- LoadSure elements for use with quick release industrial or sanitary tri-clamp connections



LoadSure® element tubing flow rates—ml/min (USGPH)

Tube material	Speed	3.2mm	6.4mm
Pumpsil®, GORE® STA-PURE® Pump Tubing – Series PCS, GORE® STA-PURE® Pump Tubing – Series PFL, Neoprene	0.1-220rpm	0.18–390 (0–6.18)	0.70–1500 (0.01–23.8)
Marprene® TM, Bioprene® TM	0.1-220rpm	0.17–370 (0–5.86)	0.67–1500 (0.01–23.8)

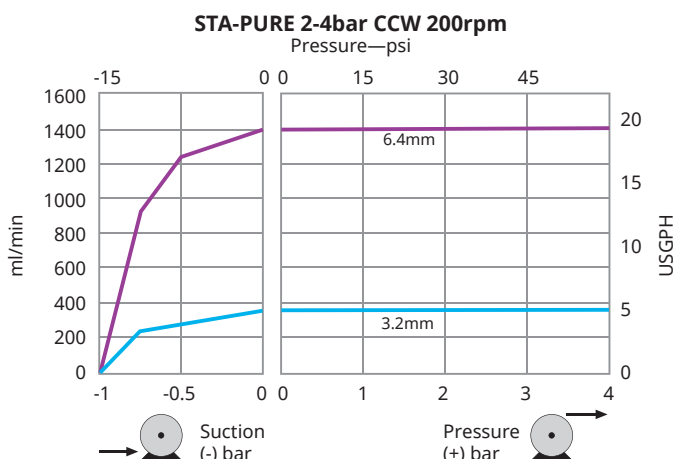
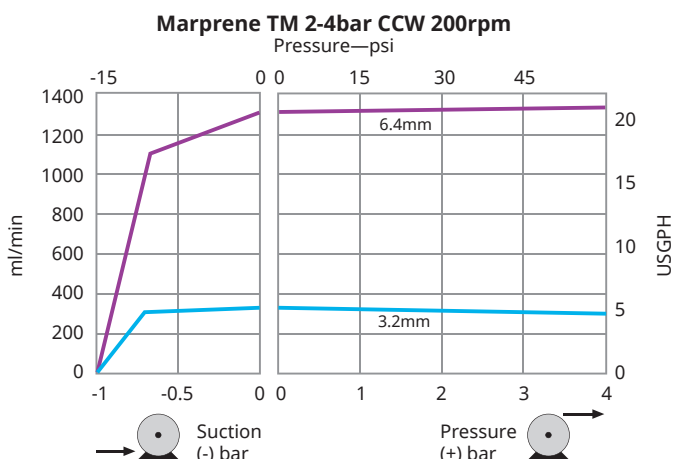

PERFORMANCE: 520REH—TWIN ROLLER PUMPHEAD FOR LOADSURE ELEMENTS

- REH—LoadSure Elements for 4–7 bar operation
- LoadSure elements for use with quick release industrial or sanitary tri-clamp connections



LoadSure® element tubing flow rates—ml/min (USGPH)		
Tube material	Speed	3.2mm
Marprene® TH, Bioprene® TH, GORE® STA-PURE® Pump Tubing - Series PCS	0.1-220rpm	0.20-450 (0-7.13)

Marprene TH/ STA-PURE PCS 4-7bar CCW 200rpm

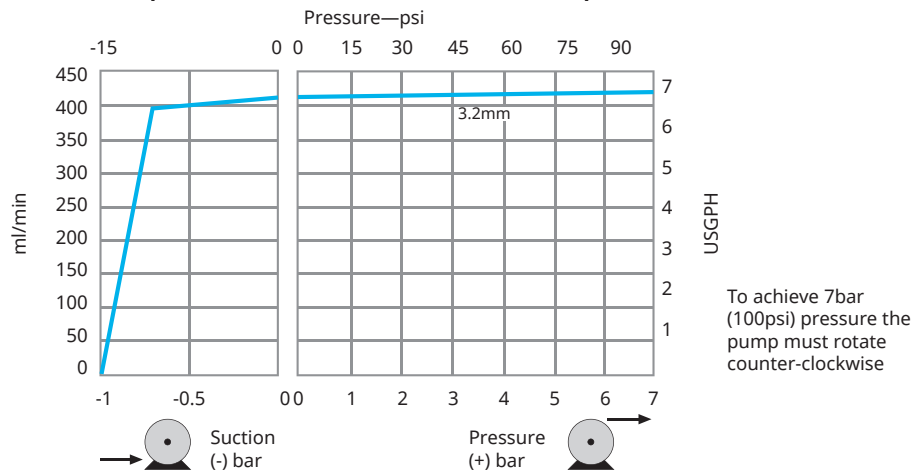

DIMENSIONS

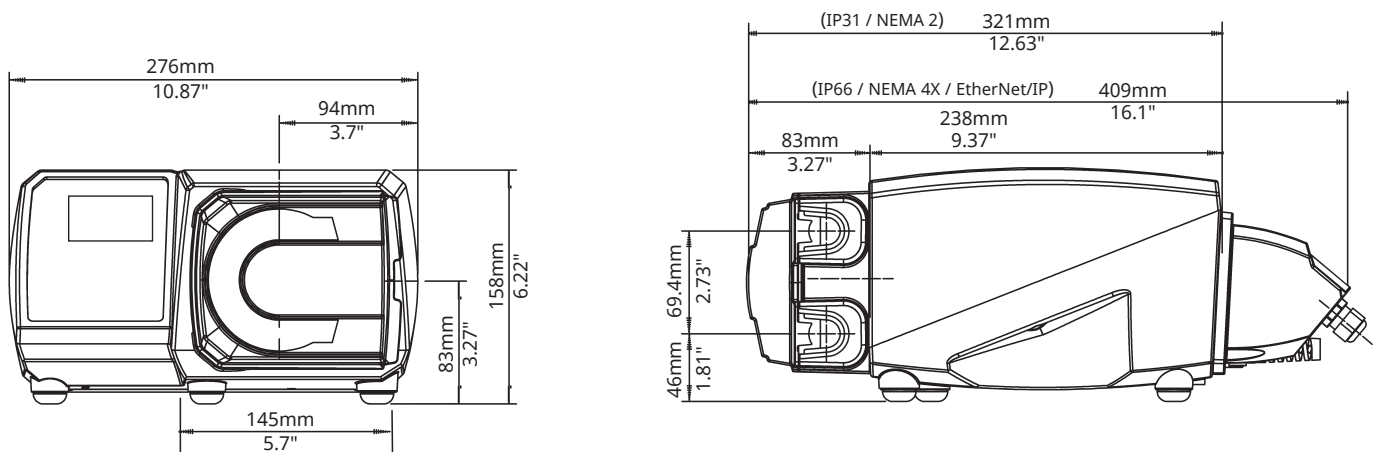

TECHNICAL DATA

Pump drives	530S	530SN	530U	530UN	530Du	530DuN	530Bp	530BpN	530US	530DuS	530En	530EnN
Model	Standard	Standard IP66 / NEMA 4X	Universal	Universal IP66 / NEMA 4X	Digital Universal	Digital Universal IP66 / NEMA 4X	Bus Pump / Profibus	Bus Pump / Profibus IP66 / NEMA 4X	Universal SCADA / IP66 / NEMA 4X	Digital Universal SCADA / IP66 / NEMA 4X	EtherNet/IP	EtherNet/IP / IP66 / NEMA 4X
Manual control												
Intuitive keypad and colour display	•	•	•	•	•	•	•	•	•	•	•	•
Choice of flowrate or speed display	•	•	•	•	•	•	•	•	•	•	•	•
Full calibration with choice of flow units	•	•	•	•	•	•	•	•	•	•	•	•
MemoDose function	•	•	•	•	•	•	•	•	•	•	•	•
Auto restart facility	•	•	•	•	•	•	•	•	•	•	•	•
Leak detection	•	•	•	•	•	•	•	•	•	•	•	•
Pump drives	530S	530SN	530U	530UN	530Du	530DuN	530Bp	530BpN	530US	530DuS	530En	530EnN
Remote control												
Configurable Start/Stop, leak detector and pressure switch input via contact closure or 5V TTL or 24V industrial logic			•	•	•	•						
Configurable Start/Stop, leak detector and pressure switch input via 110V industrial logic									•	•		
Configurable Start/Stop and leak detector input via contact closure or 5V TTL or 24V industrial logic Note: Does not include pressure switch											•	•
Direction change and auto/manual toggle input via contact closure or 5V TTL or 24V industrial logic			•	•	•	•						
Direction change and auto/manual toggle input via 110V industrial logic									•	•		
Remote operation of MemoDose (foot/hand-switch or logic input)			•	•	•	•						
Four configurable digital status outputs through 24V, 30W relays				•		•						
Four configurable digital status outputs through 110V relays									•	•		
Menu configurable logic outputs			•		•							
Remote pressure/flow sensors											•	•
Pump drives	530S	530SN	530U	530UN	530Du	530DuN	530Bp	530BpN	530US	530DuS	530En	530EnN
Analogue speed control												
Fully configurable inputs; 0-10V or 4-20mA			•	•	•	•			•	•		
Analogue outputs; 0-10V, 4-20mA			•	•	•	•			•	•		
Keypad/analogue input scaling (replacement of diaphragm pumps)					•	•				•		
Tacho frequency output; 0-991Hz			•	•	•	•						
2x sensor inputs 4-20mA*											•	•
Pump drives	530S	530SN	530U	530UN	530Du	530DuN	530Bp	530BpN	530US	530DuS	530En	530EnN
Security												
3-level Security PIN lock	•	•	•	•	•	•	•	•	•	•	•	•
Pump drives	530S	530SN	530U	530UN	530Du	530DuN	530Bp	530BpN	530US	530DuS	530En	530EnN
Network communication												
RS485 network control						•				•		
RS232 network control					•							
Pump drives	530S	530SN	530U	530UN	530Du	530DuN	530Bp	530BpN	530US	530DuS	530En	530EnN
Digital pump commands (Profibus / EtherNet/IP)												
Profibus DP V0							•	•				
Communication speeds from 9.6 kbits/s up to 12000 kbits/s							•	•				
Baud Rate (MBPS) 10/100 Full/Half Duplex Operation											•	•
Auto-detect bus speed							•	•			•	•
Speed set point							•	•			•	•
Speed feedback							•	•			•	•
Flow calibration function							•	•			•	•
Hours run							•	•			•	•
Revolution counter							•	•			•	•
Leak detection							•	•			•	•
Low fluid level alarm							•	•			•	•
Diagnostic feedback							•	•			•	•
EtherNet/IP											•	•
Device Level Ring (DLR)											•	•
Flow Totaliser											•	•

*Range of 3rd party pressure/flow sensors supported—consult factory for list

TECHNICAL SPECIFICATION

	530SN, 530UN, 530DuN	530US, 530DuS	530BpN	530EnN	530S, 530U, 530Du	530Bp	530En
Ingress rating	IP66 / NEMA 4X				IP31 / NEMA 2		
Enclosure	Watertight/dustproof				Wipe-down		
Suitability	Corrosion-resistant for heavy industrial environments				Dry industrial environments with non-corrosive atmosphere		
Humidity	(Condensing) 10-100% RH				(Non-condensing) 80% to 31C (88F), decreasing linearly to 50% at 40C (104F)		
Temperature	5C to 40C (40F to 104F)				5C to 40C (40F to 104F)		
Pump weight	10.7kg (23lb 9oz)				9.82kg (21lb 10oz)		
Speed control ratio	2200:1				2200:1		
Torque rating	2.2Nm, continuous duty				2.2Nm, continuous duty		
Profibus connection	NA		9 - PIN D SKT		NA	9 - PIN D SKT	NA
EtherNet/IP™ connection	NA			2x SKT M12D	NA		2x SKT RJ45, 1x 9-Pin D SKT
RoHS compliant	Yes						
Noise	<70dB(A) at 1m						
Standard	CE, cETLus, IRAM, C-Tick, NSF/ANSI 61 (for Marpen tubing and loadsure elements)						
Power supply	100-120V/200-240V 1ph 50/60Hz 135VA						

MATERIALS OF CONSTRUCTION

Component	Material
Keypad	Polyester
Switch-plate	Glass filled ABS plastic
Rear blanking plate	Stainless steel 304
Drive casework	Pressure die-cast aluminium LM24
Case work coating	Alocrom pre-treatment, exterior grade polyester powder coat
Drive shaft	Electroless nickel plated carbon steel
Pumphead track	PPS (polyphenylene sulphide)
Guard	Polycarbonate
Guard seal	Neoprene
Rotor hub	Stainless steel 316
Roller arms, rotor	PPS (polyphenylene sulphide)
Rollers - main	Stainless steel 316
Rollers - guide	Nylatron
Main roller bearings	Stainless steel with PTFE seals
Drain port and nut	PP (polypropylene)
Drain plug	Hytrel

ORDER INFORMATION

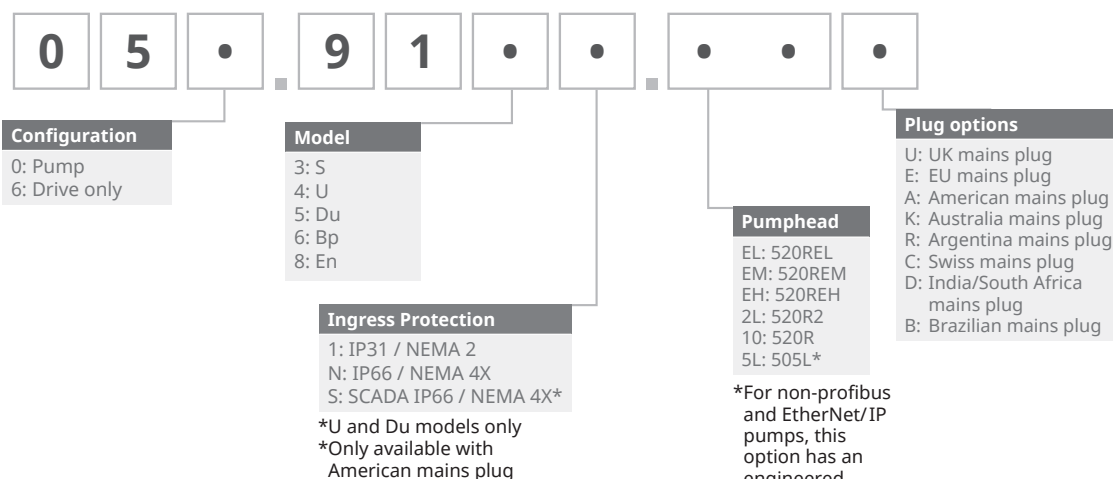

*Special NEMA module 059.911.F.100 Ethernet Watertight Module (530F) IP66 NEMA 4X is required for KROHNE flow sensor, combined with IP31 pump

ORDER INFORMATION—CONTINUED

Tubing 1.6mm wall thickness tubing for 520R								
Tube bore	Tube	Pumpsil®	PureWeld XL®	Bioprene®	STA-PURE® PCS	STA-PURE® PFL	Marprene®	Neoprene
0.5mm (1/50in)	112	913.A005.016	941.0005.016	933.0005.016	NA		902.0005.016	920.0005.016
0.8mm (1/32in)	13	913.A008.016	941.0008.016	933.0008.016	NA		902.0008.016	920.0008.016
1.6mm (1/16in)	14	913.A016.016	941.0016.016	933.0016.016	961.0016.016	966.0016.016	902.0016.016	920.0016.016
3.2mm (1/8in)	16	913.A032.016	941.0032.016	933.0032.016	961.0032.016	966.0032.016	902.0032.016	920.0032.016
4.8mm (3/16in)	25	913.A048.016	941.0048.016	933.0048.016	961.0048.016	966.0048.016	902.0048.016	920.0048.016
6.4mm (1/4in)	17	913.A064.016	941.0064.016	933.0064.016	961.0064.016	966.0064.016	902.0064.016	920.0064.016
8.0mm (5/16in)	18	913.A080.016	941.0800.016	933.0080.016	961.0080.016	966.0080.016	902.0080.016	920.0080.016

Tubing 2.4mm wall thickness tubing for 520R2								
Tube bore	Tube	Pumpsil®	PureWeld XL®	Bioprene®	STA-PURE® PCS	STA-PURE® PFL	Marprene®	Neoprene
1.6mm (1/16in)	119	913.A016.024	NA	933.0016.024	961.0016.024	966.0016.024	902.0016.024	NA
3.2mm (1/8in)	120	913.A032.024		933.0032.024	961.0032.024	966.0032.024	902.0032.024	
4.8mm (3/16in)	15	913.A048.024	933.0048.024	961.0048.024	966.0048.024	902.0048.024		
6.4mm (1/4in)	24	913.A064.024	941.0064.024	933.0064.024	961.0064.024	966.0064.024	902.0064.024	
8.0mm (5/16in)	121	913.A080.024	NA	933.0080.024	961.0080.024	966.0080.024	902.0080.024	
9.6mm (3/8in)	122	913.A096.024		933.0096.024	961.0096.024	966.0096.024	902.0096.024	

Element product codes for 520REL						
	Industrial LoadSure® elements Quick-release PVDF connectors			Sanitary LoadSure® elements 3/4 in Sanitary PVDF connectors		
	3.2mm	6.4mm	9.6mm	3.2mm	6.4mm	9.6mm
Pumpsil®	913.A032.PFQ	913.A064.PFQ	913.A096.PFQ	913.A032.PFT	913.A064.PFT	913.A096.PFT
Bioprene® TL				933.0032.PFT	933.0064.PFT	933.0096.PFT
Marprene® TL	902.0032.PFQ	902.0064.PFQ	902.0096.PFQ			
STA-PURE® Series PCS				961.0032.PFT	961.0064.PFT	961.0096.PFT
STA-PURE® Series PFL	966.0032.PFQ	966.0064.PFQ	966.0096.PFQ	966.0032.PFT	966.0064.PFT	966.0096.PFT
Neoprene	920.0032.PFQ	920.0064.PFQ	913.A096.PFQ			

Element product codes for 520REM				
	Industrial LoadSure® elements Quick-release PVDF connectors		Sanitary LoadSure® elements 3/4 in Sanitary PVDF connectors	
	3.2mm	6.4mm	3.2mm	6.4mm
Bioprene® TM			933.P032.PFT	933.P064.PFT
Marprene® TM	902.P032.PFQ	902.P064.PFQ		
STA-PURE® Series PCS			961.M032.PFT	961.M064.PFT
STA-PURE® Series PFL	966.M032.PFQ	966.M064.PFQ	966.M032.PFT	966.M064.PFT

Element product codes for 520REH		
	Industrial LoadSure® elements Quick-release PVDF connectors	Sanitary LoadSure® elements 3/4 in Sanitary PVDF connectors
	3.2mm	3.2mm
Bioprene® TH		933.H032.PFT
Marprene® TH	902.H032.PFQ	
STA-PURE® Series PCS	961.H032.PFQ	961.H032.PFT

All flow rates shown were obtained pumping water at 20C (68F) with zero suction and delivery heads. Disclaimer: The information contained in this document is believed to be correct but Watson-Marlow Limited accepts no liability for any errors it contains and reserves the right to alter specifications without notice. It is the users responsibility to ensure product suitability for use within their application. Watson-Marlow, LoadSure, Pumpsil, PureWeld XL, Bioprene, Marprene are registered trademarks of Watson-Marlow Limited. Tri-Clamp is a registered trademark of Alfa Laval Corporate AB. GORE and STA-PURE are registered trademarks of W.L. Gore and Associates. Please state the product code when ordering pumps and tubing.



wmftg.com
info@wmftg.com
+44 (0) 1326 370370