



SOFTEX® COUPLINGS

SOFTEX®
COUPLINGS

SOFTEX® COUPLINGS



CONTENT

Product description / Order code	149
Dimensions	150
Bore codes / Basic programme	151
Softex® FA flange coupling	154
Softex® TL coupling with bush	155
Misalignment values	156
Technical data spiders	157
Softex® ES zero backlash couplings	159
Technical data ES spiders	164

SOFTEX® ELASTIC COUPLINGS

SOFTEX® COUPLINGS

- Torsionally flexible, maintenance free, good dynamic properties
- Vibration reducing
- Axially pluggable
- Compact design / low flywheel effects
- Different elastomer hardnesses of the spiders
- Finish bores with keyway, taper (1:5/1:8), and tothing
- Hub materials: aluminium, cast iron, spheroidal cast iron, sintered steel and steel
- ATEX certification
- Basic programme (please see page 152) available from stock
- Special machining on request



Order code SOFTEX® COUPLINGS

Coupling type	Size	Hub	Bore	Hub	Bore	Hub material	Spider
SOFTEX®	38/45	B	Ø 38	A	N/2	Alu	92°

SOFTEX® FA COUPLINGS

- Flange hubs for heavy machinery
- All sizes are available unmachined or ready for assembly
- 2 flanges can be combined or FA flange with standard Softex® hub
- Material: cast iron



Order code SOFTEX® FA couplings

Coupling type	Size	Hub
SOFTEX®	42/55	FA

SOFTEX® TL COUPLINGS

- For all driving applications in the mechanical engineering
- Friction-locked, detachable shafts / hub connections
- Coupling combination TL 1/1; TL 2/2 and TL 1/2 possible
- Coupling hubs TL 2 axially separable
- Application with all standard taper bushes



Order code SOFTEX® TL couplings

Coupling type	Size	Hub	Bore	Hub	Bore	Spider
SOFTEX®	42/55	TL1	Ø 28	TL2	Ø 38	92°

SOFTEX® ELASTIC COUPLINGS

DIMENSIONS

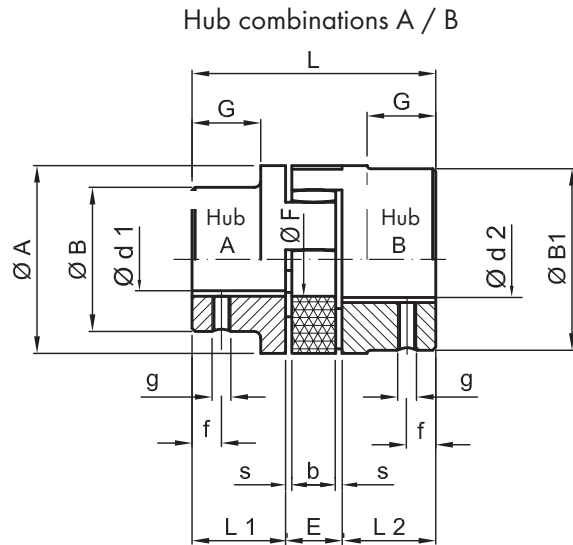

Hub combinations A / A

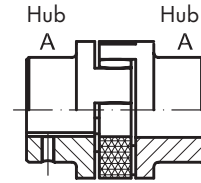

Hub combinations B / B

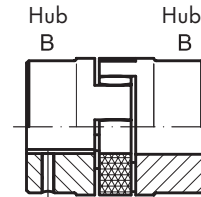

SOFTEX® type	Finish bore [mm]				Dimensions [mm]													Extended hub B	Weight [kg]
	Hub A		Hub B		ø A	ø B	ø B1	L	L1+L2	E	s	b	G	ø F	g	f	L2		
	ø d1	ø d2	min	max															
	min	max																min	max
Material: Aluminium die casting																			
19/24 Alu	6	19	20	24	40	31	38	66	25	16	2	12	20	18	M5	10	-	0.11	
24/30 Alu	8	24	25	30	55	39	48	78	30	18	2	14	24	27	M5	10	50	0.24	
28/38 Alu	10	28	30	38	65	46	61	90	35	20	2.5	15	28	30	M6	15	60	0.42	
38/45 Alu	14	38	40	45	80	64	75	114	45	24	3	18	37	38	M8	15	-	0.86	
Material: sintered steel "S", cast iron "GG", steel "ST"																			
14/16 S	-	-	4	16	30	-	30	35	11	13	1.5	10	-	8	M4	5	-	0.14	
19/24 S	-	-	6	24	40	-	40	66	25	16	2	12	-	18	M5	10	40	0.34	
24/30 S	-	-	8	32	55	-	55	78	30	18	2	14	-	27	M5	10	50	0.90	
28/38 S	-	-	10	38	65	-	65	90	35	20	2.5	15	-	30	M6	15	60	1.5	
38/45 GG*	14	38	40	45	80	66	78	114	45	24	3	18	37	38	M8	15	70	2.35	
42/55 GG*	16	42	45	55	95	75	93	126	50	26	3	20	40	46	M8	20	75	3.55	
48/60 GG*	19	48	50	60	105	85	103	140	56	28	3.5	21	45	51	M8	20	80	4.85	
55/70 GG	22	55	60	70	120	98	118	160	65	30	4	22	52	60	M10	20	90	7.4	
65/75 GG	25	65	70	75	135	115	133	185	75	35	4.5	26	61	68	M10	20	100	10.8	
75/90 GG	30	75	80	90	160	135	158	210	85	40	5	30	69	80	M10	25	110	17.7	
90/100 GG	-	-	45	100	200	-	170	245	100	45	5.5	34	81	100	M10	25	-	29.6	
100/110ST	-	-	45	110	225	-	180	270	110	50	6	38	89	113	M12	30	-	39.0	
110/125 ST	-	-	60	125	255	-	200	295	120	55	6.5	42	96	127	M16	35	-	55.0	
125/145 ST	-	-	60	145	290	-	230	340	140	60	7	46	112	147	M16	40	-	77.0	

Finish bores acc. to ISO standard H 7, keyway acc. to DIN 6885, sheet 1 - JS9

Weights refer to materials aluminium / GG with max d1 without keyway

*Sizes as A hub also available in GGG 40 (EN-GJ2-400-15)

Sizes 28/38 tp 90/100 as B hubs also available in steel (S355J2)

Assembly instruction available in the download section of our webpage www.hbe-hydraulics.com

BORE CODES

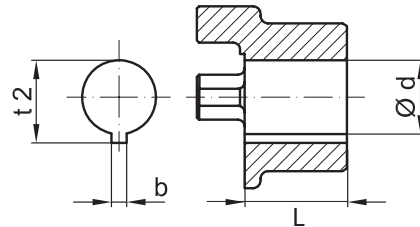
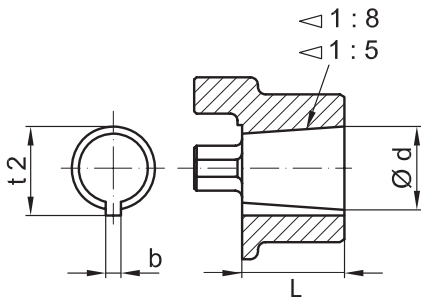

CONICAL (TAPER) BORES

Code	Bore details taper 1:8 [mm]			
	$\varnothing d + 0.05$	$b + 0.05$	$t2 + 0.1$	L
... N/1	9.7	2.4	10.7	16.5
... N/1c	11.6	3	12.9	16.5
... N/1e	13	2.4	13.8	21
... N/1d	14	3	15.5	17.5
... N/1b	14.3	3.2	15.7	19.5
... N/2	17.2	3.2	18.3	24
... N/2a	17.2	4	19.0	24
... N/2b	17.2	3	18.4	24
... N/3	22	4	23.5	28
... N/4	25.4	4.78	27.8	36
... N/4b	25.4	5	28.2	36
... N/4a	27	4.78	28.8	32.5
... N/4g	28.45	6	29.3	38.5
... N/5	33	6.35	35.5	44
... N/5a	33	7	35.5	44
... N/6	43.05	7.95	46.5	51
... N/6a	41.15	8	44.2	42.5

Code	Bore details taper 1:5 [mm]			
	$\varnothing d + 0.05$	JS9	$t2 + 0.1$	L
... A 10	9.85	2	10.85	11.5
... B 17	16.85	3	18.65	18.5
... C 20	19.85	4	22.05	21.5
... Cs 22	21.95	3	23.75	21.5
... D 25	24.85	5	27.75	26.5
... E 30	29.85	6	32.45	31.5
... F 35	34.85	6	37.45	36.5
... G 40	39.85	6	42.45	41.5

INCH BORES

Code	Metric [mm]			Inch	
	$\varnothing d$	$b + 0.05$	$t2 + 0.1$	$\varnothing d$	b
DNB	11.11 M7	2.4	12.5	7/16	3/32
V	11.11 + 0.03	3.2	12.6	7/16	1/8
Ta	12.7 + 0.03	3.2	14.3	1/2	1/8
E	15.87 + 0.03	3.2	17.5	5/8	1/8
Ed	15.87 + 0.03	4.75	18.1	5/8	3/16
ES	15.88 + 0.03	4.0	17.7	5/8	5/32
Ad	19.02 + 0.03	3.2	20.7	3/4	1/8
A	19.05 + 0.03	4.78	21.3	3/4	3/16
Gs	22.22 + 0.03	4.78	24.4	7/8	3/16
G	22.22 + 0.03	4.75	24.7	7/8	3/16
F	22.22 + 0.03	6.35	25.2	7/8	1/4
B	25.37 + 0.03	4.78	27.8	1	3/16
Bs	25.38 + 0.03	6.37	28.3	1	1/4
HS	25.4 + 0.03	6.35	28.7	1	1/4
SB	28.58 + 0.03	6.35	31.5	1 1/8	1/4
Sd	28.58 + 0.03	7.93	32.1	1 1/8	5/16
Js	31.75 + 0.03	6.35	34.6	1 1/4	1/4
J	31.75 + 0.03	7.93	34.4	1 1/4	5/16
K	31.75 M7	7.93	35.5	1 1/4	5/16
KS	31.75 + 0.03	7.93	36.6	1 1/4	5/16
M	34.92 + 0.03	7.93	38.6	1 3/8	5/16
CB	36.5 + 0.03	9.55	38.6	1 7/16	3/8
C	38.07 + 0.03	9.55	42.5	1 1/2	3/8
N	41.25 + 0.03	9.55	45.6	1 5/8	3/8
L	44.45 K7	11.11	49.4	1 3/4	7/16
NM	47.625 + 0.03	12.73	53.5	1 7/8	1/2
DS	50.77 + 0.03	12.73	56.4	2	1/2
P	53.95 + 0.03	12.73	59.6	2 1/8	1/2
U	57.1 + 0.03	12.73	62.9	2 1/4	1/2
UB	60.3 + 0.03	15.87	67.6	2 3/8	5/8
W	69.85 M7	15.875	77.3	2 3/4	5/8
WA	73.0 + 0.03	19.05	82.9	2 7/8	3/4
WD	85.725 + 0.03	22.225	95.8	3 3/8	7/8
WE	88.9 + 0.03	22.225	98.6	3 5/8	7/8
WF	92.075 M7	22.225	101.9	3 5/8	7/8

SOFTEX® ELASTIC COUPLINGS

BASIC PROGRAMME INCH BORES

SOFTEX® type	Material	Inch bores															
		A	Bs	C	Ed	Es	F	G	K	L	M	N	NM	Sb	Ta	WA	WD
19/24	Al	•			•			•							•		
	S	•						•									
24/30	Al	•	•		•	•	•	•						•			
	S	•						•									
28/38	Al	•	•	•	•	•	•	•	•					•	•		
	S	•	•					•	•	•		•					
38/45	Al	•	•					•	•	•							
	GG	•		•				•	•	•		•	•				
42/55	GG		•	•				•	•	•	•		•				
48/60	GG			•				•		•		•	•	•			
55/70	GG			•				•	•			•					
65/75	GG			•				•	•							•	
75/90	GG															•	•

BASIC PROGRAMME TAPER BORES

SOFTEX® type	Material	Taper 1:5				Taper 1:8				
		A10	B17	C20	D25	N/1	N1d	N/2	N/2a	N/3
19/24	Al	•				•	•			
	S	•				•	•			
24/30	Al	•	•	•	•	•	•	•	•	•
	S		•	•	•			•	•	•
28/38	Al		•	•	•			•	•	•
	S		•	•	•			•	•	•
38/45	Al		•		•			•	•	•
	GG		•		•			•	•	•
42/55	GG		•		•			•	•	•

AVAILABLE INTERNAL TOOTHINGS

SAE profile	Profile DIN 5480	Profile DIN 5482	Profile DIN 5462
8/16 x 13Z*	N20 x 1,25	A17 x 14	B8 x 32 x 36*
8/16 x 15Z	N25 x 1,5	A22 x 19	
8/16 x 17Z	N30 x 2	A25 x 22	
12/24 x 14Z*	N35 x 2*	A28 x 25	
12/24 x 17Z*	N40 x 2	A30 x 27	
16/32 x 9Z*	N45 x 2	A35 x 31	
16/32 x 11Z	N50 x 2*	A40 x 36	
16/32 x 13Z*	N55 x 2	A45 x 41*	
16/32 x 15Z*	N60 x 2	A48 x 44	
16/32 x 21Z	N70 x 3	A50 x 45	
16/32 x 23Z	N80 x 3	A58 x 53	
16/32 x 27Z	N90 x 3		

*Basic programme

BASIC PROGRAMME METRIC BORES

SOFTEX® type	Material	Hub	Finish bores acc. ISO standard H 7, keyway acc. to DIN 6885, sheet 1 [mm]																							
			6	8	9	10	11	12	14	15	16	18	19	20	22	24	25	28	30	32	35	38	40	42	45	
19/24	Al	A	•	•	•	•	•	•	•	•	•	•														
		B											•	•	•											
	S	B				•	•	•	•	•	•	•	•	•	•											
		B-verl.							■				■			■										
24/30	Al	A				•	•	•	•	•	•	•	•	•	•											
		B															•	•	•							
		B-verl.												■			■		■							
	S	B				•	•	•	•	•	•	•	•	•	•	•	•	•	•							
B-verl.																		■								
28/38	Al	A							•	•	•	•	•	•	•	•										
		B																			•	•	•	•		
		B-verl.																						■		
	S	B									•	•	•	•	•	•	•	•	•	•	•	•	•	•	•	
B-verl.																							■			
38/45	Al	A																								
		B																						•	•	•
	GG	A																								
		B																							•	•
		B-verl.																							■	

SOFTEX® type	Material	Hub	Finish bores acc. to ISO standard H7, keyway acc. to DIN 6885, sheet 1 [mm]																						
			22	24	25	28	30	32	35	38	40	42	45	48	50	55	60	65	70	75	80	85	90	100	
42/55	GG	A	•	•	•	•	•	•	•	•	•														
		B												•	•	•	•								
		B-verl.												■		■		■							
48/60	GG	A				•	•	•	•	•	•	•	•												
		B																							
		B-verl.																							
55/70	GG	A																							
		B																							
		B-verl.																							
65/75	GG	A																							
		B																							
75/90	GG	A																							
		B																							
90/100	GG	A/B																							

Al = Aluminium; S = sintered steel; GG = cast iron; B-verl. = Hub B extended

SOFTEX® FA ELASTIC FLANGE COUPLINGS

DIMENSIONS

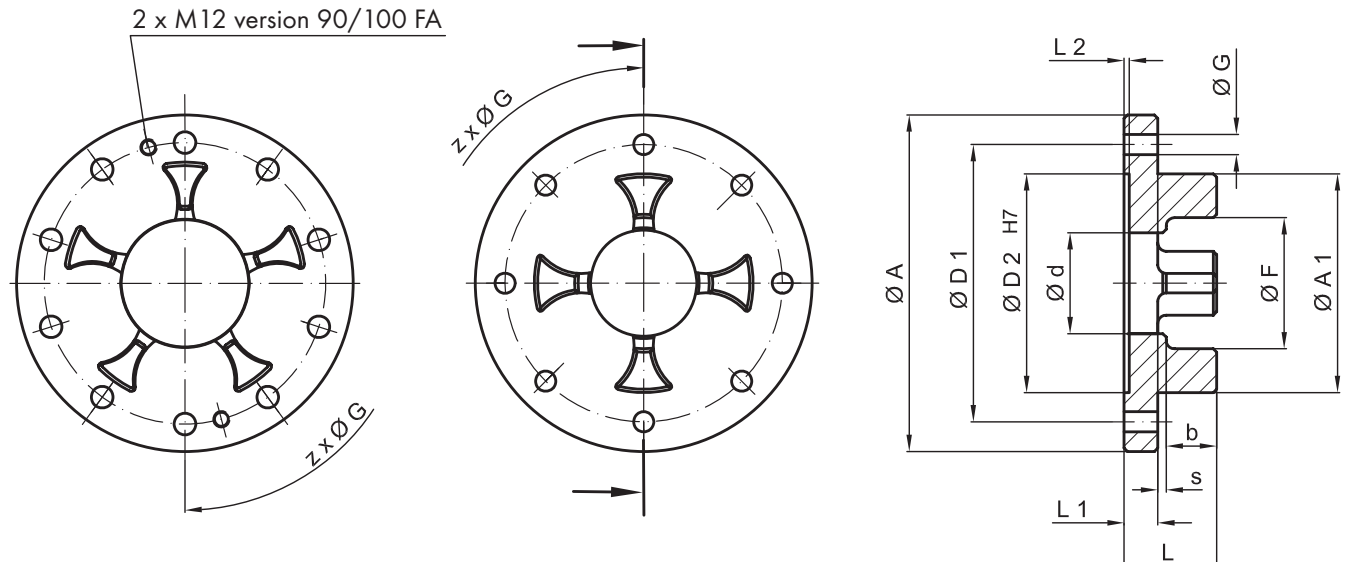

Art. No.	Type	Dimensions [mm]													Number of z	Weight ¹⁾ [kg]
		ø A	ø A1	L	L1	s	b	ø F	L2	ø D1	ø D2	ø d	ø G			
6468	24/30 FA	80	55	24	8	1	15	35	1.5	65	55	27	4.5	5	0.33	
6741	28/38 FA	100	65	27.5	10	1.5	16	39	1.5	80	65	30	7	6	0.55	
6991	38/45 FA	115	80	31	10	2	19	48	1.5	95	80	38	7	6	0.75	
7188	42/55 FA	140	95	35	12	2	21	57	2	115	95	46	9	6	1.35	
7391	48/60 FA	150	105	36.5	12	2.5	22	63	2	125	105	51	9	8	1.55	
7471	55/70 FA	175	120	42	16	2.5	23.5	74	2	145	120	60	11	8	2.70	
7692	65/75 FA	190	135	46.5	16	3	27.5	83	2	160	135	68	11	10	3.30	
7897	75/90 FA	215	160	54	19	3.5	31.5	98	2.5	185	160	80	14	10	4.90	
8056	90/100 FA	260	200	59.5	20	4	35.5	122	3	225	200	100	14	12	6.70	
8103	100/110 FA	285	225	69	25	6	38	137	4	250	225	113	14	12	9.5	

¹⁾Weights refer to material GG.

For combinable standard hubs, please see chart on page 150 and for all technical data please see pages 156 to 158. All sizes are also available unmachined without dimensions D1-D2-12-G.

SOFTEX® TL ELASTIC COUPLINGS WITH TAPER BUSH

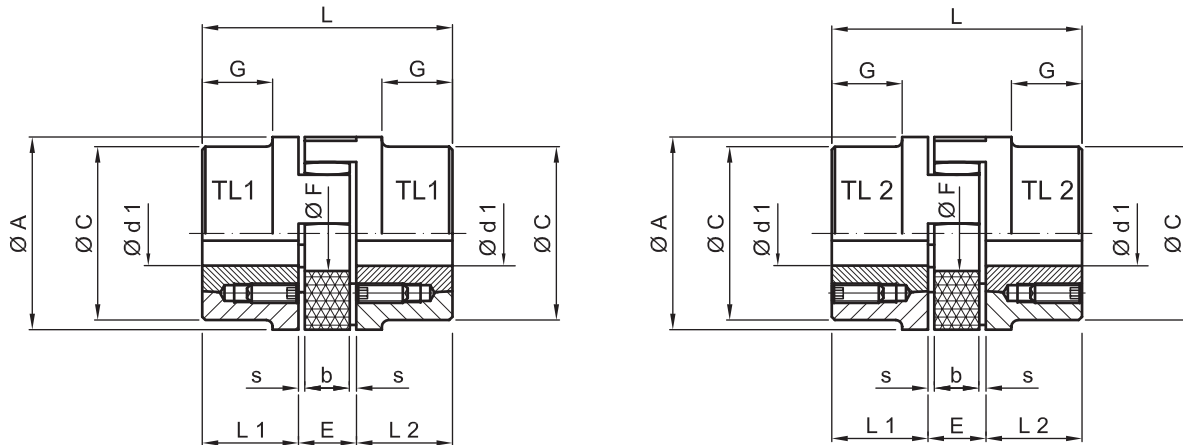

SOFTEX® type	Taper bush	Dimensions [mm]									Weight [kg]
		ø A	ø C	L	L1 + L2	E	s	b	G	ø F	
28/38	1108	65	65	66	23	20	2,5	15	-	30	1.0
38/45	1108	80	78	70	23	24	3	18	15	38	2.7
42/55	1610	95	93	78	26	26	3	20	16	46	3.0
48/60	1615	105	103	106	39	28	3.5	21	28	51	4.8
55/70	2012	120	118	96	33	30	4	22	20	60	4.9
65/75	2012	135	115	101	33	35	4.5	26	19	68	6.9
75/90	2517 ¹	160	158	144	52	40	5	30	36	80	14.5
	3020 ²										

¹only available for TL 1

²only available for TL 2

SOFTEX® type	Moment of inertia ³ [kg m ²]	Fixing screws for taper bush			
		Size [inch]	Length [mm]	Number	Tightening torque [Nm]
28/38	0.0007	1/4	13	2	5,6
38/45	0.0030	1/4	13	2	5,6
42/55	0.0036	3/8	16	2	20
48/60	0.0080	3/8	16	2	20
55/70	0.0120	7/16	22	2	31
65/75	0.0140	7/16	22	2	31
75/90	0.0650	1/2	25	2	50
		5/8	32		90

³with max. bore diameter

Taper bush size	Available bore dimensions ø d1 [mm]																		
1108	9	10	11	12	14	16	18	19	20	22	24	25	28*						
1610	14	16	18	19	20	22	24	25	28	30	32	35	38	40	42*				
1615	14	16	18	19	20	22	24	25	28	30	32	35	38	40	42*				
2012	14	16	18	19	20	22	24	25	28	30	32	35	38	40	42	45	48	50	
2517	16	18	19	20	22	24	25	28	30	32	35	38	40	42	45	48	50	55	60

standard H7; keyway acc. to DIN 6885 sheet 1; *bore with keyway (flat version) DIN 6885 sheet 3

SOFTEX® ELASTIC COUPLINGS

MISALIGNMENT VALUES

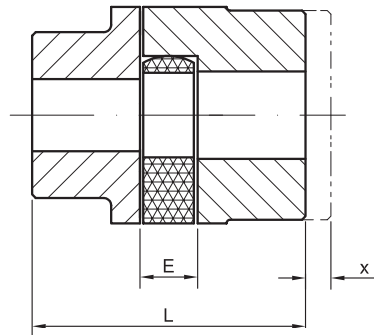

Axial displacement

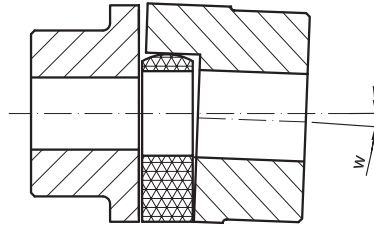

Angular displacement or

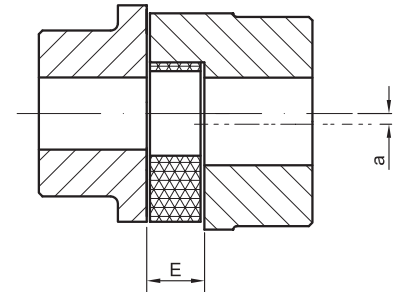

Radial displacement

SOFTEX® type	Coupling dimensions		Max. misalignments		
	E [mm]	L [mm]	Axial ¹ x [mm]	Angular ¹ w [°]	Radial ¹ a [mm]
14/16	13	35	1.0	0.9	0.17
19/24	16	66	1.2	0.9	0.2
24/30	18	78	1.4	0.9	0.22
28/38	20	90	1.5	0.9	0.25
38/45	24	114	1.8	1	0.28
42/55	26	126	2.0	1	0.32
48/60	28	140	2.1	1.1	0.36
55/70	30	160	2.2	1.1	0.38
65/75	35	185	2.6	1.2	0.42
75/90	40	210	3.0	1.2	0.48
90/100	45	245	3.4	1.2	0.50
100/110	50	270	3.8	1.2	0.52
110/125	55	295	4.2	1.3	0.55
125/145	60	340	4.6	1.3	0.60

¹at speed of 1,500 1/min

The specified values are guide values and are based on the nominal torque T_{KN} , the speed and the ambient temperature of +30°C.

In case of axial misalignments, the factors "E" and "L" are the max. values.

When mounting the coupling, dimension "E" must be set exactly in order to keep the coupling axially flexible.

In case of additional angular and radial displacement, the values should be used pro rata. The misalignment values are depending on speed and performance.

The stability of the coupling will be increased by careful alignment of the shafts.



Assembly instruction available in the download section of our webpage www.hbe-hydraulics.com

TECHNICAL DATA SPIDERS

SOFTEX® type	80° Shore A [Nm]			92° Shore A [Nm]			98° Shore A [Nm]			64° Shore D [Nm]			Max. speed [1 / min]	
	Cont. T _{KN}	max. T _{Kmax.}	Alter- nating T _{KW}	Cont. T _{KN}	max. T _{Kmax.}	Alter- nating T _{KW}	Cont. T _{KN}	max. T _{Kmax.}	Alter- nating T _{KW}	Cont. T _{KN}	max. T _{Kmax.}	Alter- nating T _{KW}	v=30 m/s	v=40 m/s
14/16	4	8	1	7.5	15	2	12.5	25	3.3	-	-	-	19000	-
19/24	4.9	9.7	1.3	10	20	2.6	17	34	4.4	-	-	-	14000	19000
24/30	17	34	4.4	35	70	9	60	120	16	75	150	20	10600	14000
28/38	46	92	12	95	190	25	160	320	42	200	400	52	8500	11800
38/45	93	186	24	190	380	49	325	650	85	405	810	105	7100	9500
42/55	130	260	34	265	530	69	450	900	120	560	1120	145	6000	8000
48/60	150	300	39	310	620	81	525	1050	137	655	1310	170	5600	7100
55/70	180	360	47	410	820	93	685	1370	163	750	1500	195	4750	6300
65/75	205	410	53	625	1250	111	940	1880	169	800	1600	208	4250	5600
75/90	475	950	124	1280	2560	254	1920	3840	390	1830	3660	476	3550	4750
90/100	1175	2350	306	2400	4800	624	3600	7200	963	4500	9000	1170	2800	3750
100/110	-	-	-	-	-	-	4950	9900	1287	-	-	-	2500	3350
110/125	-	-	-	-	-	-	7200	14400	1560	-	-	-	2240	3000
125/145	-	-	-	-	-	-	7500	15000	1950	-	-	-	2000	2650

For peripheral speeds exceeding $V = 30$ m/s dynamically balanced hubs made of GGG or steel instead of GG hubs are required.

TECHNICAL FEATURES SPIDERS

Characteristics	80° Shore A	92° Shore A	98° Shore A	64° Shore D
Colour				
Material	Polyurethane			Hytrel
Permissible durable temperature range	-50°C up to +80°C	-40°C up to +90°C	-30°C up to +90°C	-50°C up to +110°C
Permissible short term temperature peaks	-60°C up to +80°C	-50°C up to +120°C	-40°C up to +120°C	-60°C up to +150°C
Damping	Very good	Good	Medium	Low
Elasticity	Soft	Medium	Hard	Very hard
Wear resistance	Very good	Very good	Good	Good
Durability	Excellent	Very good	Very good	Very good
Typical applications	Normal drives, also with resonance speed possibility	Normal drives	Normal drives with high performance	High performance with small torsional angle

SOFTEX® ELASTIC COUPLINGS

SERVICE FACTORS COUPLING SELECTION

Service factor K1						
Type	Driven machine / Example	Prime motor				
		E-motor	Diesel / petrol engines (cylinders)			
			≥ 4	3	2	1
a	Uniform operation with small masses to be accelerated Hydraulic and centrifugal pump, light generators, ventilators, transport systems	1.0 - 1.25	1.2 - 1.5	1.5 - 1.7	1.7 - 2.0	2.4 - 2.7
b	Uniform operation with medium masses to be accelerated Bending machines, wood processing machines, textile machines, tooling machines, conveyors, mixer, agitators	1.6 - 1.8	1.7 - 2.0	2.0 - 2.3	2.3 - 2.5	2.8 - 3.0
c	Irregular operation with medium masses to be accelerated Printing machines, dye machines, grinders, ring spinning machines, wood processing machines, conveyors, generators, centrifugal pumps and agitators for semifluid goods, freight elevators, mixers, shredders, lifts	1.8 - 1.9	2.0 - 2.0	2.3 - 2.5	2.5 - 2.7	2.9 - 3.1
d	Irregular operation with medium masses to be accelerated and shocks Concrete mixers, threshing machines, blowers, overhead tracks, planing machines, chain conveyor, cranes, millstones, mills, lifts, slat conveyors, press pumps, ship shafts, rope winches, road rollers, compressors, roller mills, looms, centrifuges	1.8 - 2.0	2.2 - 2.5	2.5 - 2.7	2.7 - 3.0	3.1 - 3.4
e	Irregular operation with large masses to be accelerated and heavy shocks xcavators, roll stands, wire drawing, hammer mills, wood grinder, piston pumps / compressors with light flywheel, presses, Rotary rigs, vibromachines, scissors, forge presses, punching machines	2.1 - 2.3	2.5 - 2.7	2.7 - 3.0	3.2 - 3.4	3.5 - 3.8
f	Irregular operation, very large masses to be accelerated and very heavy shocks Piston compressors / pumps without speed regulation, heavy roller conveyors, welding generators, stone crushers, rolling mills for metals, brick presses	2.5 - 3.1	3.0 - 3.3	3.3 - 3.6	3.7 - 4.0	4.1 - 4.5

Safety factor K2			
Operation period (hours / day)			
more than	-	2	12
up to	2	12	24
Factor K2	0.9	1	1.1

Safety factor K3					
Starts per hour					
more than	-	10	40	125	500
up to	10	40	125	500	-
Type a - c	1	1.05	1.3	1.45	1.6
Type d - f	1	1.05	1.1	1.15	1.5

Further factors					
Further factors	Definition				
Starting factor S_z	z	100	200	400	800
	S_z	1	1.2	1.4	1.6
Temperature factor S_T	T [°C]				S_T
	-25°C		+30°C		1.0
	+30°C		+40°C		1.2
	+40°C		+60°C		1.4
	+60°C		+80°C		1.6
Shock factor S_N/S_L	Slight starting shock				1.5
	Medium starting shock				1.8
	Heavy starting shock				2.2

Coupling selection*

$$T_N = T_{KN} \times K1 \times K2 \times K3$$

*The largest possible torque T_N should be used as a basis. The catalogue torque T_{KN} has to be multiplied with all safety factors. For drives with dangerous torsional vibrations, the critical speed must be considered.

SOFTEx® ES NO BACKLASH COUPLINGS

PRODUCT DESCRIPTION

- Under initial tension no backlash shaft connection
- Triple axially pluggable version
- Simple blind mounting, no time-consuming screwings
- Small structural dimensions – low flywheel effects
- Maintenance free, simple optical test
- Different elastomer hardnesses of the spiders
- Available for all common shaft dimensions
- Finish bores with ISO standard H7, (clamping hub F7), keyway from $\varnothing 6$ acc. to DIN 6885 sheet 1-JS9
- Hub materials: aluminium up to size 38/45, steel for larger sizes

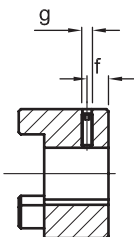
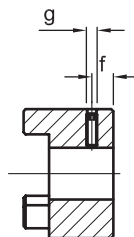
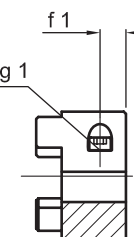
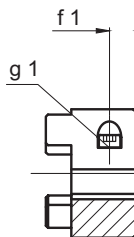
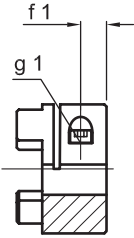
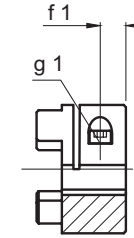

HUB TYPES

<p>1.0 Type 1.0 with keyway and fixing screw</p>  <ul style="list-style-type: none"> • Positive transmission • Permissible torque depending on permissible surface pressure • Not suitable for backlash-free power transmission for heavily reversing operation 	<p>1.1 Type 1.1 without keyway with fixing screw</p>  <ul style="list-style-type: none"> • Non-positive locking torque transmission • Suitable for a backlash transmission of very low torques
<p>2.0 Type 2.0 slotted once without keyway</p>  <ul style="list-style-type: none"> • Frictional, backlash shaft-hub-connection • Transmissible torques depending on bore diameter • Up to size 19/24 	<p>2.1 Type 2.1 slotted once with keyway</p>  <ul style="list-style-type: none"> • Positive transmission with additional frictional connection • Due to frictional connection a reverse backlash is prevented resp. reduced • Surface pressure of the keyway connection is reduced
<p>2.5 Type 2.5 slotted twice without keyway</p>  <ul style="list-style-type: none"> • Frictional, backlash shaft-hub-connection • Transmissible torques depending on bore diameter • From size 24/30 	<p>2.6 Type 2.6 slotted twice with keyway</p>  <ul style="list-style-type: none"> • Positive transmission with additional frictional connection • Due to frictional connection a reverse backlash is prevented resp. reduced • Surface pressure of the keyway connection is reduced

Order code SOFTEx® ES no backlash couplings

Coupling type	Size	Bore	Design	Bore	Design	Spider
SOFTEx® ES	19/24	24F7	2.0	19H7	1.0	98°

SOFTEX® ES NO BACKLASH COUPLINGS

DIMENSIONS

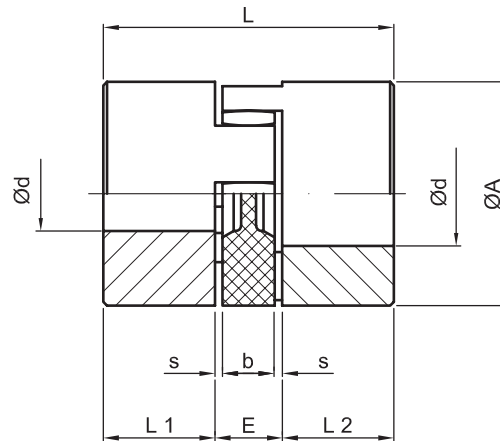

SOFTEX® ES type	Finish bores* [mm]			Dimensions [mm] 1.0/1.1								Clamping screw 2.0/2.5			
	Hub type			Ø A	L	L1, L2	E	b	s	g	f	g ₁	f ₁	T _A [Nm]	
	1.0	1.1	2.0/2.5												
Material: aluminium															
9	9	11	11	20	30	10	10	8	1.0	M4	5	M2.5	5.0	0.76	
14	15	16	16	30	35	11	13	10	1.5	M4	5	M3	5.0	1.34	
19/24	24	24	20	40	66	25	16	12	2.0	M5	10	M6	12.0	10.5	
24/30	30	30	28	55	78	30	18	14	2.0	M5	10	M6	10.5	10.5	
28/38	38	38	38	65	90	35	20	15	2.5	M8	15	M8	11.5	25.0	
38/45	45	45	45	80	114	45	24	18	3.0	M8	15	M8	15.5	25.0	

*Special bores on request

BORE RANGE Ød AND CORRESPONDING TRANSFERABLE FRICTION TORQUES T_r [Nm] OF THE CLAMPING HUB

Type 2.0																				
SOFTEX® ES type	Finish bore [mm]																			
	8	9	10	11	14	15	16	19	20	24	25	28	30	32	35	38	40	42	45	50
9	2.5	2.6	2.7	2.8																
14	5.1	5.3	5.5	5.6	8.1	6.3	6.5													
19/24	25	26	27	27	29	30	31	32	34											

Type 2.5																				
SOFTEX® ES type	Finish bore [mm]																			
	10	11	14	15	16	19	20	24	25	28	30	32	35	38	40	42	45	50	55	60
24/30	34	35	36	38	39	19	41	43	45	46										
28/38			80	81	81	85	87	91	92	97	99	102	105	109						
38/45				92	94	98	99	104	105	109	112	113	118	122	123	126	130			
42/55							232	244	246	255	260	266	274	283	288	294	301	309	315	
48/60									393	405	413	421	434	445	454	462	473	486	494	514

Finish bores hub types 1.0 and 1.1 H7 fit,
types 2.0 and 2.5 F7 fit keyway acc. to DIN 6885, sheet 1 Tol. JS 9

SOFTEX® ES NO BACKLASH COUPLINGS (6.0 / 6.0P)

TYPE 6.0

- Zero backlash shaft connection under high friction torque
- For Servo motor applications such as main spindle drives of tooling machines and heavy load of presses
- No imbalances of keyways or slotted clamping elements
- Smooth running with good stability even at 40 m/s peripheral speed
- Also suitable for ATEX explosion protection applications (when considering the selection in accordance with the influence of high friction torques)
- Easy assembly by internal clamping screws
- ISO fit H7 up to \varnothing 50 mm and ISO fit G7 over \varnothing 50 mm
- Materials: Hub = aluminium / clamping ring = steel, both also available in steel S355J2



Order code type 6.0

Coupling type	Size	Bore	Type	Bore	Type	Spider
SOFTEX® ES	28	28H7	6.0	25H7	6.0	98°

TYPE 6.0P

- High precision, zero backlash shaft connection under high friction torque
- Developed for high speed short and multi spindles for tooling machines (DIN 69002)
- Smooth running with good stability even at 75 m/s peripheral speed
- Also suitable for ATEX explosion protection applications (when considering the selection in accordance with the influence of high friction torques)
- Easy assembly by internal clamping screws
- Spiders with 98° SH A or 64° SH D incl. bore required
- ISO fit H6
- Hub and clamping ring made of 42CrMo4



Order code type 6.0P

Coupling type	Size	Bore	Type	Bore	Type	Spider
SOFTEX® ES	28	28H6	6.0P	25H6	6.0P	64°

SOFTEX® ES NO BACKLASH COUPLINGS (6.0 / 6.OP)

DIMENSIONS

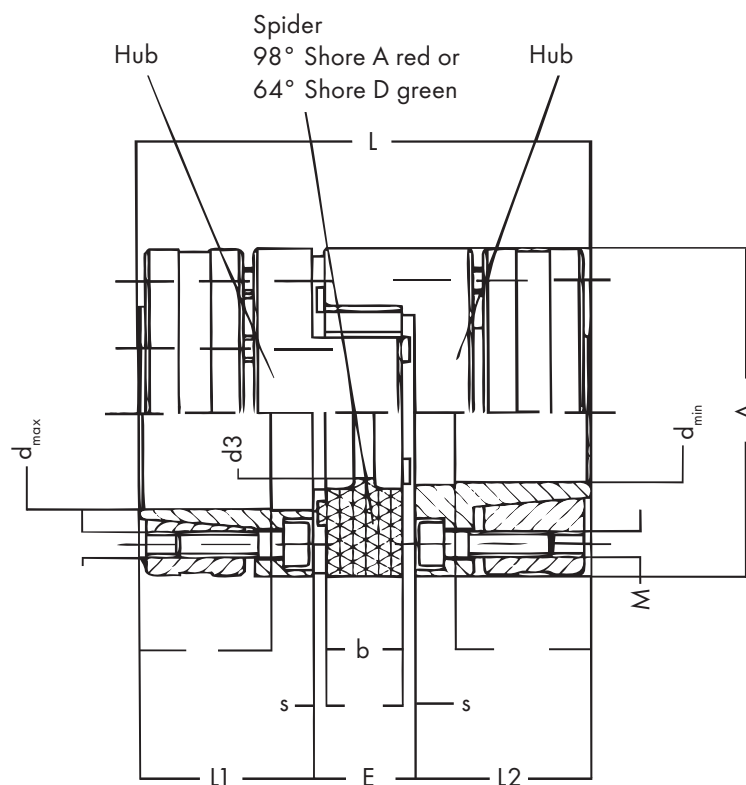

SOFTEX® ES type	Dimensions [mm]									
	A	L	L1 + L2	E	s	b	d _{min}	d _{max}	d3*	M
14P	30	50	18.5	13	1.5	10	8	14	8.5	M3
19P	40	66	25	16	2.0	12	10	20	9.5	M4
24P	55	78	30	18	2.0	14	14	28	12.5	M5
28P	65	90	35	20	2.5	15	18	38	14.5	M5
38P	80	114	45	24	3.0	18	20	40	16.5	M6
42P	95	126	50	26	3.0	20	28	50	18.5	M8
48P	105	140	56	28	3.5	21	32	48	20.5	M10

*only with type 6.OP

TECHNICAL DATA

SOFTEX® ES type	Material		Clamping screw 6.0			Hub 6.0		Clamping screw 6.0P			Hub 6.0P	
	Hub	Clamp- ing ring	Size	Number	TA	Weight [kg]	Moment of inertia J [kg cm²]	Size	Number	TA	Weight [kg]	Moment of inertia J [kg cm²]
			M	z	[Nm]			M	z	[Nm]		
14	AL-H	ST	M3	4	1.34	0.049	0.07	-	-	-	-	-
19	AL-H	ST	M4	6	3	0.120	0.31	-	-	-	-	-
24	AL-H	ST	M5	4	6	0.280	1.35	-	-	-	-	-
28	AL-H	ST	M5	8	6	0.450	3.13	-	-	-	-	-
38	AL-H	ST	M6	8	10	0.950	9.60	-	-	-	-	-
42	ST	ST	M8	4	35	2.300	31.7	-	-	-	-	-
48	ST	ST	M10	4	69	3.080	52.0	-	-	-	-	-
14P	42CrMo	-	-	-	-	-	-	M3	4	2	0.08	0.1
19P	42CrMo	-	-	-	-	-	-	M4	6	3	0.19	0.37
24P	42CrMo	-	-	-	-	-	-	M5	4	8.5	0.44	2.0
28P	42CrMo	-	-	-	-	-	-	M5	8	8.5	0.64	4.4
38P	42CrMo	-	-	-	-	-	-	M6	8	14	1.32	13.3
42P	42CrMo	-	-	-	-	-	-	M8	4	35	2.30	30.0
48P	42CrMo	-	-	-	-	-	-	M10	4	69	3.09	50.0

Bore range d and corresponding transferable friction torques Tr [Nm]
of the clamping ring hub

Nm	ø 6	ø 10	ø 11	ø 14	ø 15	ø 16	ø 19	ø 20	ø 24	ø 25	ø 28	ø 30	ø 32
14	8.6	13.8	15	22.7									
19		31	37	62	68	70	83	90					
24				67	74	80	90	97	112	120	143		
28					142	154	189	190	237	250	280	307	310
38								269	337	356	396	436	442
42										399	445	506	470
48												650	685

Bore range d and corresponding transferable friction torques Tr [Nm]
of the clamping ring hub

Nm	ø 35	ø 38	ø 40	ø 42	ø 45	ø 48	ø 50	ø 55
14								
19								
24								
28	353	389						
38	501	533	572	615	644			
42	566	581	647	630	728	836	858	
48	809	841	926	916	1042	1181	1125	1311

SOFTEX® ES NO BACKLASH COUPLINGS

TECHNICAL DATA SPIDERS



SOFTEX® ES type	Spider	Torque [Nm]			Max. speed [1/min] V=30 m/s	Static elongation per unit force [Nm/rad]	Permissible misalignment at n=1500 1/min			Radial elongation per unit force Cr [N/mm]	Weight* [kg]	Moment of inertia* J [kgcm ²]
		T _{SP}	Cont. T _{KN}	max. T _{Kmax}			Axial Δ ka [mm]	Radial Δ kr [mm]	Angular Δ kw [°]			
9	92A	0.45	3	6	28000	32	0.8	0.15	1.0	260	0.015	0.01
	98A		5	10		51		0.09	0.9	520		
	64D		6	12		74		0.05	0.9	739		
14	92A	1	7,5	15	13000	114	1.0	0.15	1.0	335	0.06	0.06
	98A		12,5	25		172		0.09	0.9	605		
	64D		16	32		234		0.06	0.8	856		
19/24	92A	2.5	10	20	10000	570	1.2	0.10	1.0	1120	0.13	0.37
	98A		17	34		855		0.07	0.9	2010		
	64D		21	42		1240		0.04	0.8	2830		
24/30	92A	-	35	70	7000	1430	1.4	0.14	1.0	1780	0.28	1.35
	98A		60	120		2060		0.10	0.9	2565		
	64D		75	150		2980		0.07	0.8	3696		
28/38	92A	-	95	190	6000	2292	1.5	0.15	1.0	1785	0.46	3.10
	98A		160	320		3440		0.11	0.9	3200		
	64D		200	400		4350		0.09	0.8	4348		
38/45	92A	-	190	380	5000	4.584	1.8	0.17	1.0	2350	0.90	9.62
	98A		325	650		7160		0.12	0.9	4400		
	64D		405	810		10540		0.09	0.8	6474		
42/55	92A	-	265	530	4000	9800	2.0	0.19	1.0	4100	2.70	57.40
	98A		450	900		15180		0.14	0.9	5940		
	64D		560	1120		16500		0.10	0.8	7590		
48/60	92A	-	310	620	3600	12000	2.1	0.23	1.0	4500	3.60	95.80
	98A		525	1050		16600		0.16	0.9	6820		
	64D		655	1310		31350		0.11	0.8	9000		

- In case of higher speeds a dynamic balancing of the hubs is required.
- The length dimension L is increased by the indicated Δ ka values.
- The specified misalignment values are general guide values.

- In case of current angular and radial misalignment the indicated values can only be utilised proportionately.
- In case of a temperature increase the permissible torques and the max. permissible radial and angular misalignment values must be multiplied by the temperature factor St.

*Complete coupling type 1.0 with medium bore on both sides

Temperature	-25°C < +30°C	+30°C < +40°C	+40°C < +60°C	+60°C < +80°C
Temperature factor St	1.0	1.2	1.4	1.8

Characteristics	92° Shore A		98° Shore A	64° Shore D
Colour				
Material	Polyurethane		Polyurethane	Hytrel
Permissible temperature range	-40°C up to +90°C		-30°C up to +90°C	-50°C up to +120°C
Permissible temperature peaks	-50°C up to +120°C		-40°C up to +120°C	-60°C up to +150°C
Applications	Servo drives, positioning drives, main spindle drives, planetary gears, no backlash gears			

Online catalogue



epaper.hbe-hydraulics.com/en

HBE hydraulic
components

HBE GmbH
Hönnestraße 47
58809 Neuenrade /Germany

Phone +49 (0) 23 94 / 616-0
Fax +49 (0) 23 94 / 616-25
info@hbe-hydraulics.com
www.hbe-hydraulics.com



e.holding
FLUID TECHNOLOGY GROUP
www.e-holding.de

distributed by