

**TECHSPEC® 0.20X SilverTL™ Telecentric Lens**

#63-073



0.20X Magnification

TECHSPEC® SilverTL™ Telecentric Lenses are ideal for both on-line and off-line machine vision production applications that require accurate measurements. These lenses combine high-quality optics with a simplified non-focusing mechanical design and an adjustable iris with a locking set screw. These lenses are designed for metrology and gauging applications. TECHSPEC® SilverTL™ Telecentric Lenses also offer inline illumination options for maximum versatility. Each lens also features a standard front filter thread for use with [color filters](#), [polarizers](#), [protective windows](#), and [illumination adapters](#) for LED or fiber-optic ring lights.

**Note:** Mounting brackets are available that fit the 30mm diameter mounting surface.

Length excluding Threads (mm):	188.00
Working Distance Tolerance (mm):	±3
Resolution, Image Space MTF @ f/10:	>40% @ 40 lp/mm
Coating:	425 - 675nm BBAR
Construction:	Anodized Aluminum
Depth of Field (mm):	±12.9 at f/10 (20% @ 20 lp/mm)

## Optical

Horizontal Field of View, 1/2" Sensor:	32mm
Horizontal Field of View, 1/3" Sensor:	24mm
Numerical Aperture NA, Object Side:	0.016
Horizontal Field of View, 1/1.8" Sensor:	35.9mm
Typical Telecentricity @ 588nm (°):	<0.055
Typical Distortion @ 588nm (%):	<0.150
Primary Magnification PMAG:	0.2X
Maximum Sensor Format:	1/1.8"
Working Distance (mm):	164.00
Aperture (f/#):	f/6 - f/22
FOV @ Max Sensor Format, H x V (mm):	36.0 x 27.0
Lens Wavelength Range:	VIS

## Mechanical

Filter Thread:	M58 x 0.75 (Female)
Maximum Diameter (mm):	60.00
Weight (g):	346
Number of Elements (Groups):	6 (5)
Mount:	C-Mount

## General

Stock No. of Mounting Clamp:	<a href="#">#56-871</a> Sold Separately
Type:	Telecentric Lens



#63-073, 0.20X SilverTL™ Telecentric Lens, Distortion Plot

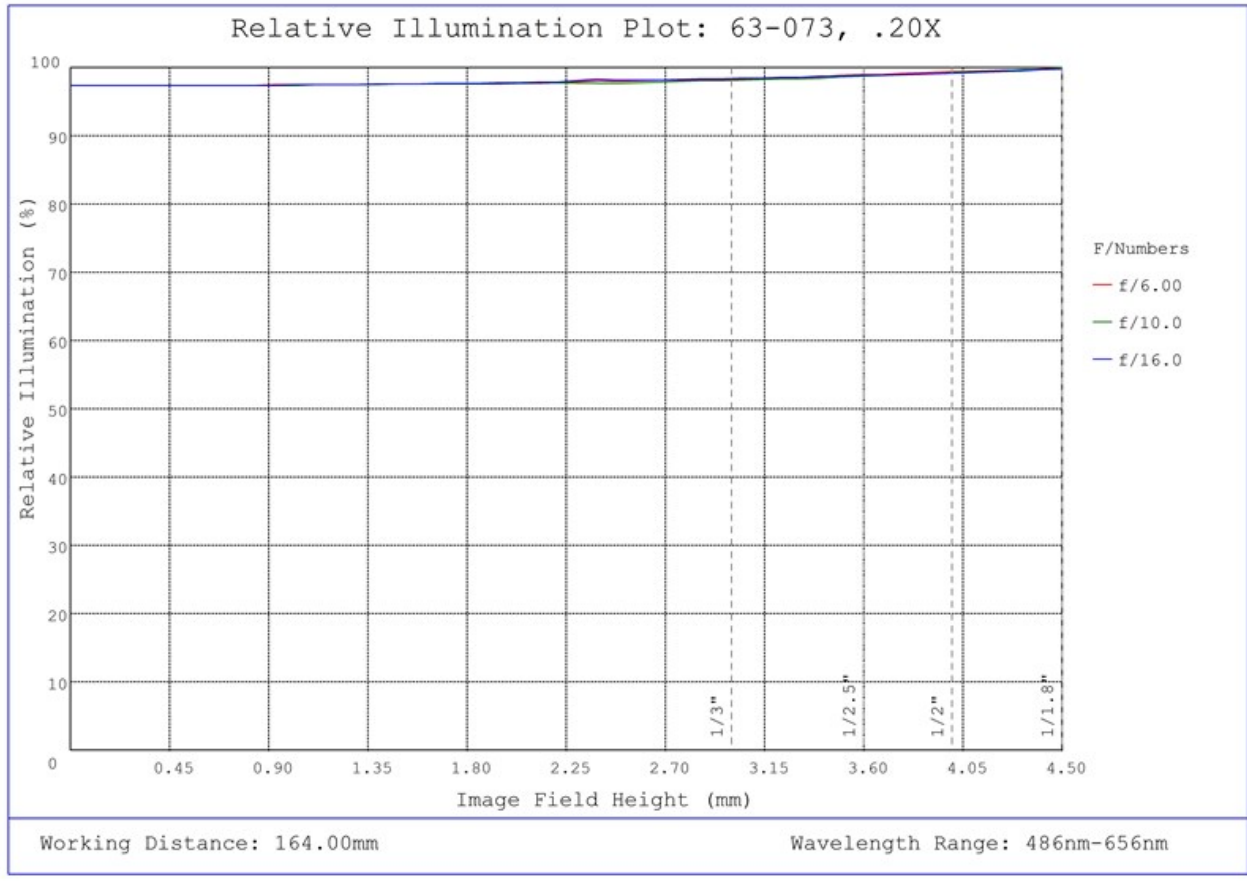

#63-073, 0.20X SilverTL™ Telecentric Lens, Relative Illumination Plot

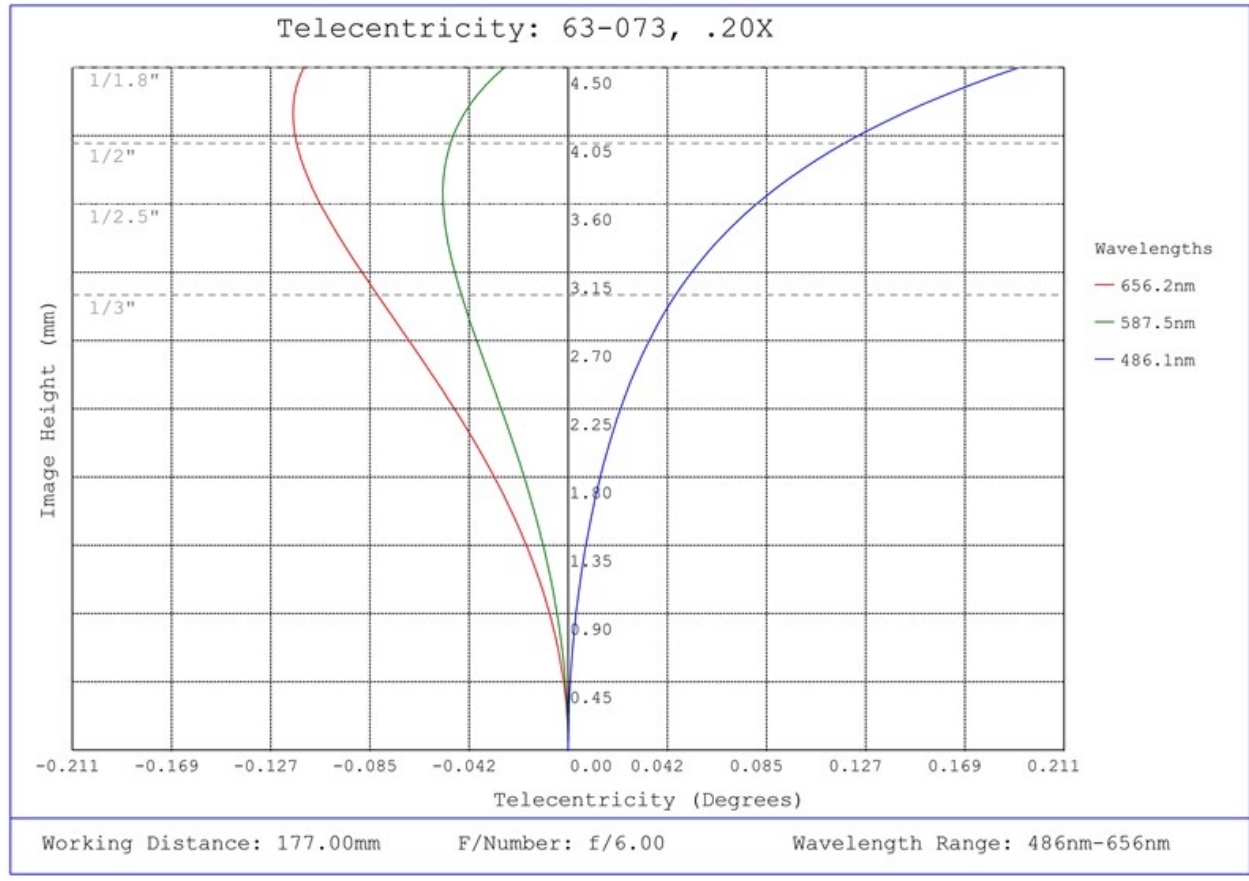

#63-073, 0.20X SilverTL™ Telecentric Lens, Telecentricity Plot

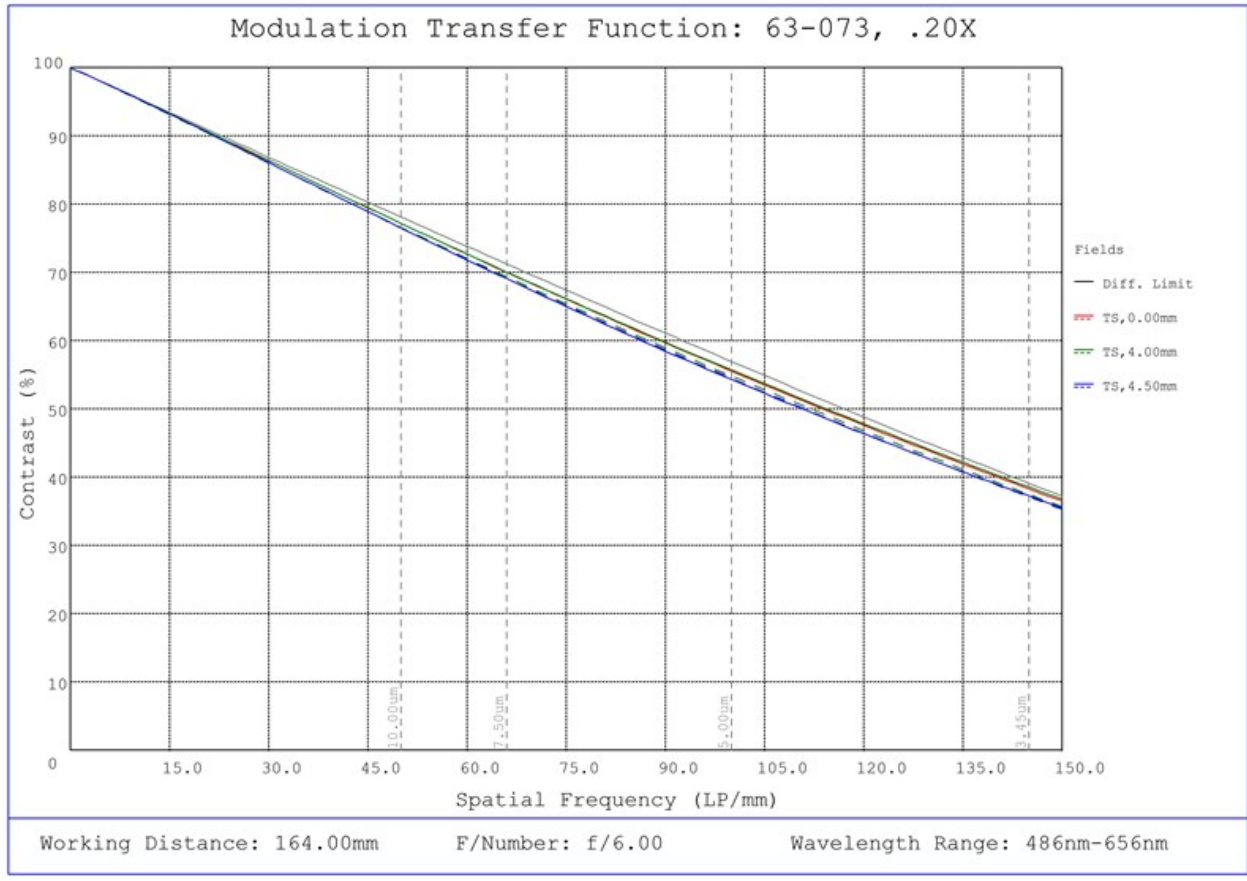

#63-073, 0.20X SilverTL™ Telecentric Lens, Modulated Transfer Function (MTF) Plot, 164mm Working Distance, f6

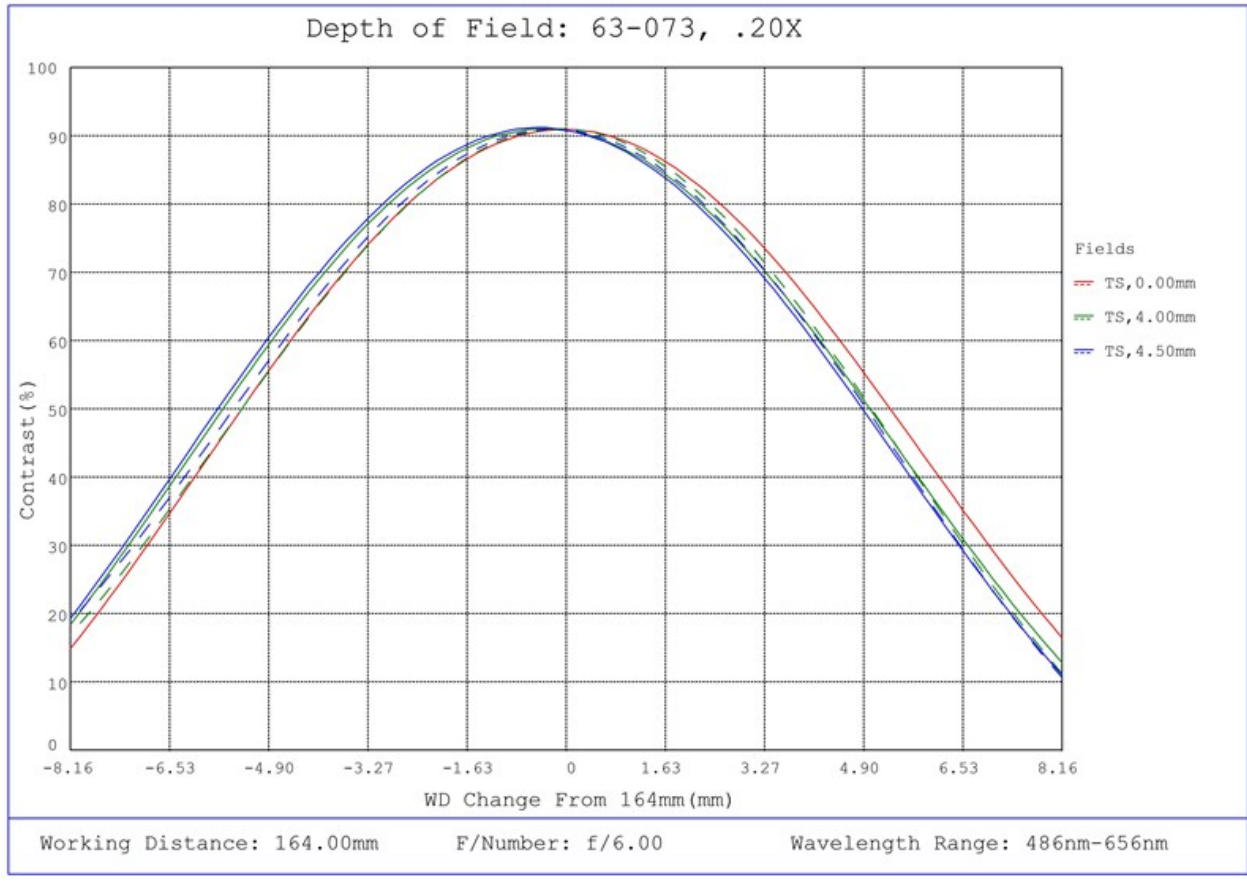

#63-073, 0.20X SilverTL™ Telecentric Lens, Depth of Field Plot, 164mm Working Distance, f6



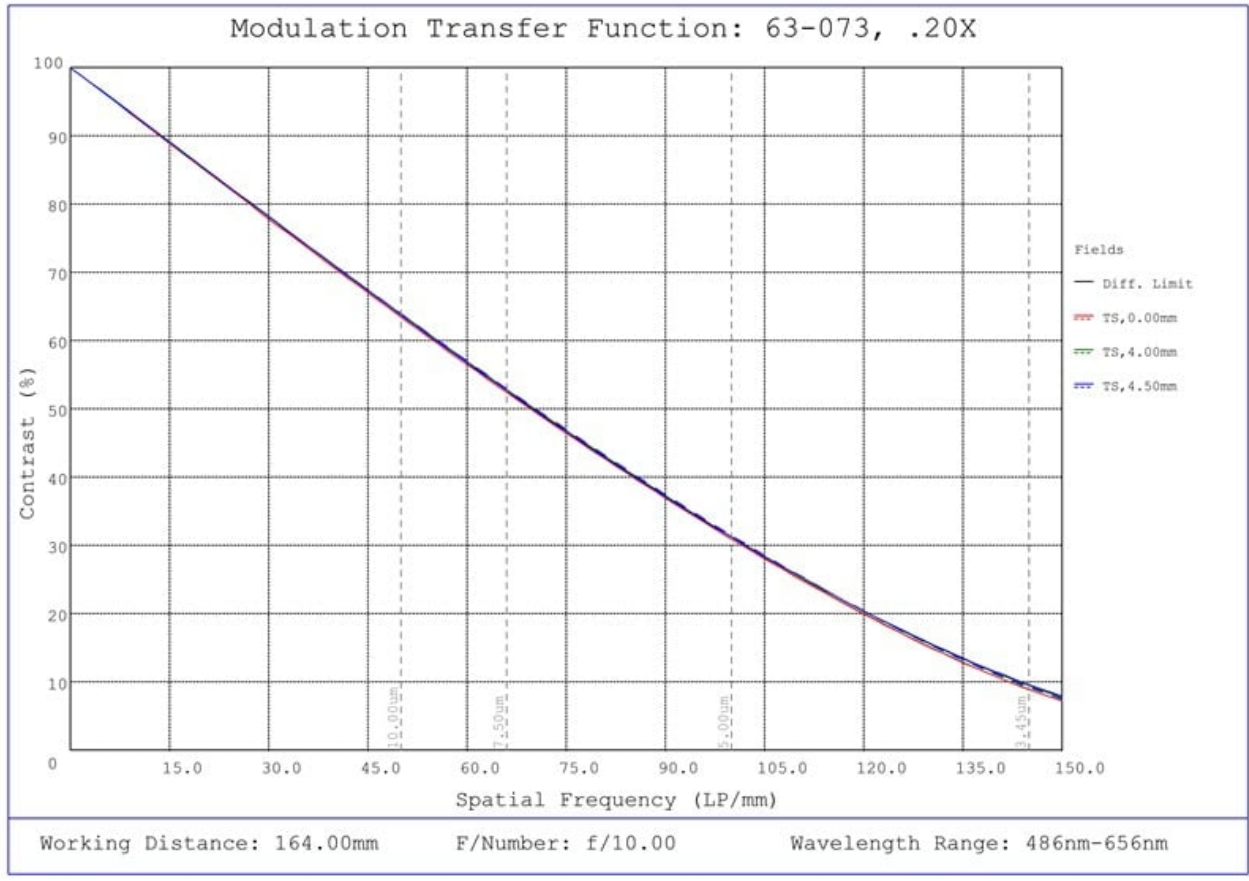

#63-073, 0.20X SilverTL™ Telecentric Lens, Modulated Transfer Function (MTF) Plot, 164mm Working Distance, f10



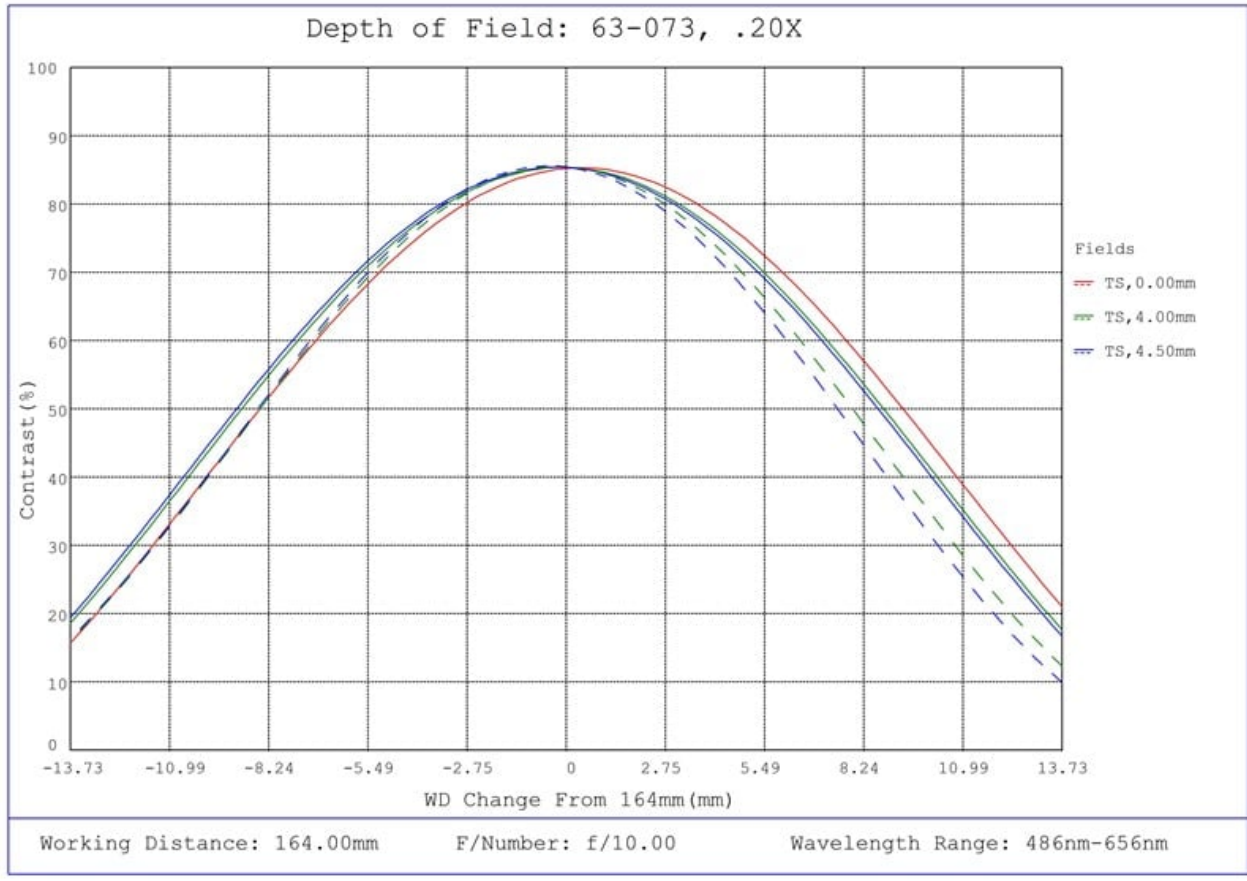

#63-073, 0.20X SilverTL™ Telecentric Lens, Depth of Field Plot, 164mm Working Distance, f10



December 08, 2023

To Whom It May Concern,

This document certifies that the product stated below has been reviewed as requested by Edmund Optics:

<i>Stock No.</i>	<i>Description</i>
63-073	0.20X SilverTL™ Telecentric Lens

This item is EU RoHS (System.Threading.Tasks.Task`1[Microsoft.AspNetCore.Html.HtmlString]/EU) compliant without the use of exemptions.

This certification means that:

- EO's suppliers have confirmed the material composition of this product.
- EO has implemented rigorous procedures to document this compliance.
- The information provided may, or may not, be based upon actual test data, or on information from our Vendors, Raw Material Suppliers or Subcontractors.



Jay Budd, Director of Corporate Compliance  
December 08, 2023

Edmund Optics Inc. - 101 E Gloucester Pike, Barrington, NJ 08007 | 1-800-363-1992 | [Compliance@edmundoptics.com](mailto:Compliance@edmundoptics.com)



December 08, 2023

To Whom It May Concern,

This document certifies that the product stated below has been reviewed as requested by Edmund Optics:

<i>Stock No.</i>	<i>Description</i>
63-073	0.20X SilverTL™ Telecentric Lens

This item does not contain any of the substances listed on the Reach SVHC list as of System.Threading.Tasks.Task`1[Microsoft.AspNetCore.Html.HtmlString] in quantities exceeding 0.1% weight by weight.

Please note the following:

- Entry 11 of Annex V of the REACH regulation as amended by regulation 987/2008, exempts “non-hazardous” glass components from registration.
- Items considered to be packing materials and which do not form part of, or are not required for the operation of, the product, are not considered to be within scope of this declaration.
- EO does not routinely analyze products for substances not purposely added or specified within the design specifications, drawings and assembly procedures.

This certification means that:

- EO's suppliers have confirmed the material composition of this product.
- EO has implemented rigorous procedures to document this compliance.
- The information provided may, or may not, be based upon actual test data, or on information from our Vendors, Raw Material Suppliers or Subcontractors.



Jay Budd, Director of Corporate Compliance  
December 08, 2023

Edmund Optics Inc. - 101 E Gloucester Pike, Barrington, NJ 08007 | 1-800-363-1992 | [Compliance@edmundoptics.com](mailto:Compliance@edmundoptics.com)



December 08, 2023

<i>Stock No.</i>	<i>Description</i>
63-073	0.20X SilverTL™ Telecentric Lens

Edmund Optics certifies that all articles included in this shipment are in compliance with the terms and conditions of this order. The company also certifies that the articles included in this shipment are in accordance to all agreed upon specifications and quality assurance provisions. Please call 1-800-363-1992 should any questions arise from this shipment.



Jeff Harvey- EVP of Operations

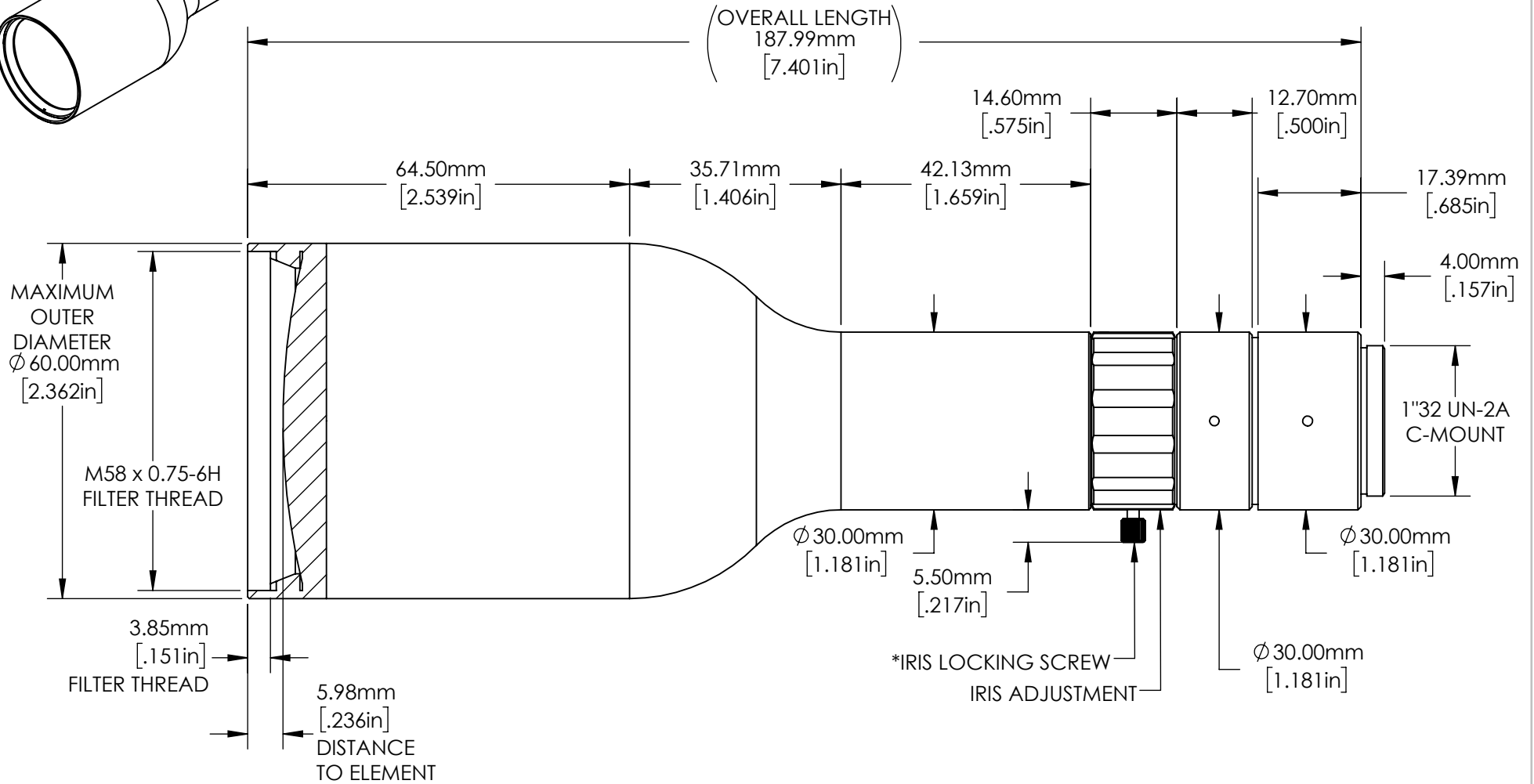
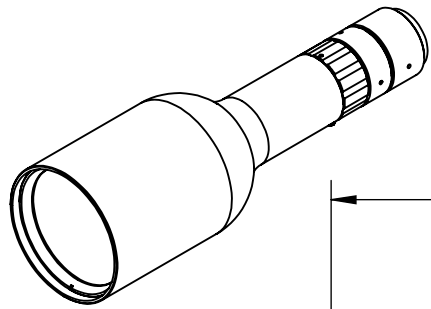

\*ALSO INCLUDES RECESSED SET SCREW OPTION

**FOR INFORMATION ONLY:  
DO NOT MANUFACTURE  
PARTS TO THIS DRAWING**

SPECIFICATIONS SUBJECT TO CHANGE  
WITHOUT NOTICE  
DIMENSIONS ARE FOR REFERENCE ONLY.  
FOR DETAILED SPECIFICATIONS, PLEASE  
REFER TO THE SPEC SHEET.

**Edmund Optics®**

TITLE	0.20X SilverTL™ Telecentric Lens	
DWG NO	63073	SHEET 1 OF 1