

Photoelectric Sensor

Z / BGS-Z series



- High Performance, Low Cost! All models offer cost and space savings.
- ZR-Q series. Ideal for detection of transparent objects! Plastic bottles, film, etc.
- ZR-X/QX series, Coaxial beam. Sensing through narrow opening is possible!
- BGS-Z series. High performance in small package!!
Tough sensor! 100G shock resistance and IP67 ratings.

Applications

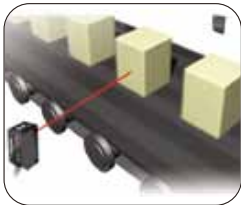

For material handling
(ZR-350)

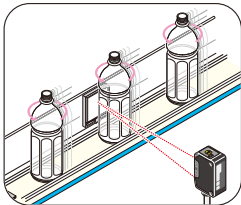

Beverage industry
(ZR-QX200)

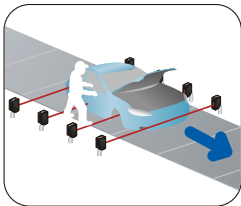

Car on the production line
(ZT-1200)



PCB
(BGS-Z10N)

Thru-Beam type



ZT-1200N/ZT-1200P
ZT-1200CN/ZT-1200CP

Convergent type

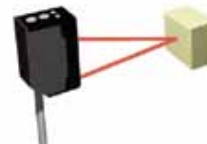

ZD-L09N/ZD-L09P
ZD-L09CN/ZD-L09CP

Retro Reflective type



ZR-350N/ZR-350P
ZR-350CN/ZR-350CP

Diffuse type (incl,divergent type)

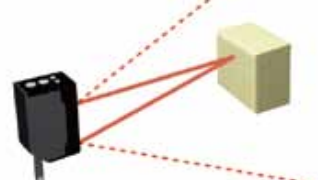

Diffuse
ZD-70N/ZD-70P
ZD-70CN/ZD-70CP

Divergent
ZD-W20N/ZD-W20P
ZD-W20CN/ZD-W20CP

BGS type



BGS-Z30N/BGS-Z30P
BGS-Z30CN/BGS-Z30CP
BGS-Z10N/BGS-Z10P
BGS-Z10CN/BGS-Z10CP

Coaxial LED type



General use
ZR-X250N/ZR-X250P
ZR-X250CN/ZR-X250CP

Transparent objects
ZR-QX200N/ZR-QX200P
ZR-QX200CN/ZR-QX200CP

C
C2
E
J
J2
J3
V
V2
V3
V4
SR-Q
S
Z
BGS-Z
Z2
Z3
ZM
K
BGS-ZS
Y
DM-18T
Accessory

General Purpose

- **100G shock resistance, IP67 ratings. Tough sensor !**
- **ZR-Q series, ideal for detection of PET bottles, transparent objects, etc.**
- **Standard models for cost saving.**

Features

500μsec response

Good for fast moving objects.

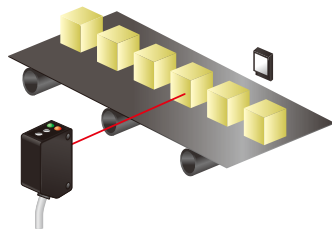

Cross-talk prevention

With built-in cross-talk prevention, it is possible to mount two sensors side-by-side without mutual interference.

(Use part number BL-100-POLF for thru-beam type sensors.)

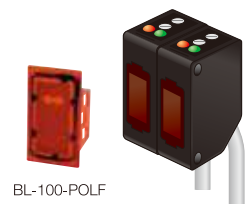

ZD-W20 wide angle applications

The Divergent type ZD-W20 provides a wide angle beam that can be used to detect transparent film by collecting the reflected light from the material surface.

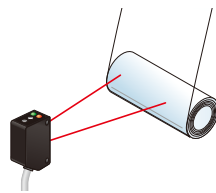

IP67 rating

Hose it down!
Water-tightness is tested to IP67.



Rugged 100G shock rating

Rigid design for high resistance to mechanical shock

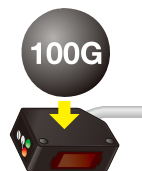

Threaded mounting holes

Prevents sensor from being damaged when it's mounted.



Specifications

Model	Thru-beam	Polarized Retro-reflective	Diffuse-reflective	Convergent	Divergent	Glass detection	
Cable type	NPN	ZT-1200N	ZR-350N	ZD-70N	ZD-L09N	ZD-W20N	ZR-Q200N
	PNP	ZT-1200P	ZR-350P	ZD-70P	ZD-L09P	ZD-W20P	ZR-Q200P
M8 Connector type	NPN	ZT-1200CN	ZR-350CN	ZD-70CN	ZD-L09CN	ZD-W20CN	ZR-Q200CN
	PNP	ZT-1200CP	ZR-350CP	ZD-70CP	ZD-L09CP	ZD-W20CP	ZR-Q200CP
Sensing distance	12 m	3.5m (V-61 reflector)	70cm	1-9 cm	1-200 mm	2 m (V-61 reflector)	
Response time	0.5 msec						
Spot size	1.5m @ 12 meter	350mm @ 3.5 meter	100mm @ 700mm	12mm @ 90mm	30mm @ 50mm	300mm @ 2 meter	
Operating mode	Light On/Dark On selectable						
Hysteresis	NIL		20% Max	10% Max	20% Max	NIL	
Light source	Red LED						
Sensitivity adjustment	1-turn trimmer (240 degree)						
Control output	NPN or PNP Open collector, 100mA Max / 30V DC						
Supply voltage	DC 10 - 30V incl. 10% ripple						
Power consumption	20mA Max						
LED Indicator	Dual Indicator (Output : orange, Stable : green)						
Protection category	IP67						
Shock resistance	100G (1,000m/S ²)						
Environmental illuminance	Sunlight : 10,000 lux Max., Incandescent lamp : 3,000 lux max.						
Operating temp/humidity	-25 to 55°C / 35 to 85%RH						
Materials	ABS with glass fiber (Case), PMMA (Lens)						

Retro-Reflective with Coaxial LED

The best for transparent Plastic / Glass detection

- **Coaxial LED source gives extremely tight alignment to the target.**
- **Alignment of sensor is easy thanks to bright projected LED spot.**
- **250 μsec fast response (ZR-X, coaxial beam type)**
- **World's standard model ZR-Q (general type) and ZR-QX (coaxial beam type) for Plastic and Glass applications.**

Features

Zero dead area!

The sensor has no dead area in the sensing field. This makes it ideal for use on conveyors where the position of the target changes.

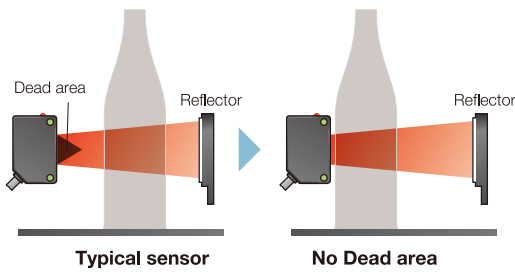

Good selection of sensors for various types of bottles.

Glass and plastic bottles come in various shapes / sizes and with many different contours which require testing in the field to determine the best sensor for the application.

The Z series is offered with both Co-axial and Conventional LED light sources to provide a solution for the detection of any bottle type.

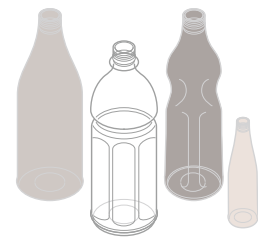

Repeat Accuracy

Very tight Repeat Accuracy, 0.2 - 0.3mm for BGS type. Even Thru-beam and Retro types have 0.3mm Repeat Accuracy(*).

*=Tested at the middle point of sensing range.

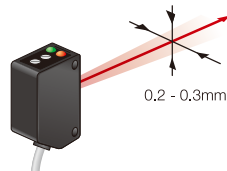

Coaxial LED

Coaxial LED light source provides extremely tight alignment to the target, Alignment of sensor is very easy thanks to bright projected LED spot.

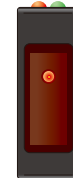

Specifications

Model		Retro Reflective for Transparent				Polarized Retro-reflective	
		General Use		Coaxial Beam		(Coaxial Beam)	
		2m Cable	M8QD 4pin	2m Cable	M8QD 4pin	2m Cable	M8QD 4pin
Type	NPN PNP	ZR-Q200N ZR-Q200P	ZR-Q200CN ZR-Q200CP	ZR-QX200N ZR-QX200P	ZR-QX200CN4 ZR-QX200CP4	ZR-X250N ZR-X250P	ZR-X250CN4 ZR-X250CP4
Sensing distance		0.01 - 2 meter (V-61 reflector)		0 - 2 meter (P250F reflector)		0 - 2.5 meter (V-61 reflector)	
Response time		0.5 msec				250μs	
Spot size		φ300mm / at 2m		φ60mm / at 2m		φ60mm / at 2m	
Operating mode		Light On / Dark On selectable					
LED Indicator		Output : orange, Stable : green		Output : orange		Output : orange, Stable : green	
Light source		Red LED					
Sensitivity adjustment		1-turn pot.					
Control output		NPN or PNP open collector, 100mA max / DC30V					
Supply voltage		DC 10 - 30V, including 10% ripple					
Power consumption		20mA max					
Protection category		IP 67					
Shock resistance		100G (1,000m/S ²)					
Environmental illuminance		Sunlight : 10,000 lux max., Incandescent lamp : 3,000 lux max					
Operating temp/humidity		-25 to 55°C/ 35 to 85% RH					
Materials		ABS(Case), PMMA(Lens)					

"M8-QD in 3 pins for European machines " are available with extension code of -CN(P)3, for instance, "ZR-QX200CN3".

- C
- C2
- E
- J
- J2
- J3
- V
- V2
- V3
- V4
- SR-Q
- S
- Z**
- BGS-Z
- Z2
- Z3
- ZM
- K
- BGS-2S
- Y
- DM-18T
- Accessory

BGS - LED Type

General purpose applications

- **BGS (Background Suppression Type) Sensors are not influenced by the background, available with conventional LED light source.**

Features

500μsec response

Good for fast moving objects.

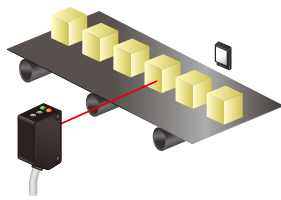

Large projected spot size

The LED version of the BGS sensors projects a large 6 mm spot that will not be affected by small holes in a PC board.

For PC boards that may have larger holes, the BGS-Z30 has an 18 mm projected spot size.

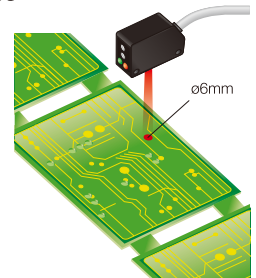

High power narrow beam LED

LED beam spot can be seen easily even in bright environment that helps installation.

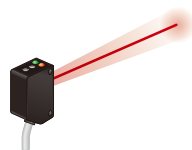

4 Turn adjustment pot.

A four turn adjustment pot. is built-in for precise adjustment of the sensing distance.

The potentiometer has a slip clutch that protects it from damage when it is turned past the end.



Specifications

Model		long distance		short distance	
		2m Cable	M8QD 4pin	2m Cable	M8QD 4pin
Type	NPN	BGS-Z30N	BGS-Z30CN	BGS-Z10N	BGS-Z10CN
	PNP	BGS-Z30P	BGS-Z30CP	BGS-Z10P	BGS-Z10CP
Adjustable distance		50 - 300 mm (*1)		20 -100 mm (*1)	
Sensing distance		10 - 300 mm (*1)		5 -100 mm (*1)	
Response time		500μs			
Spot size		φ30mm / 300mm		φ10mm / 100mm	
Hysteresis (white to white)		5%		3%	
Operating mode		Light On / Dark On selectable			
LED Indicator		Output : orange, Stable : green			
Light source		Red LED			
Sensitivity adjustment		4-turn, endless pot.			
Control output		NPN or PNP open collector, 100mA max / DC30V			
Supply voltage		DC 10 - 30V, including 10% ripple			
Power consumption		30mA max			
Protection category		IP 67			
Shock resistance		100G (1,000m/S ²)			
Environmental illuminance		Sunlight : 10,000 lux max., Incandescent lamp : 3,000 lux max			
Operating temp / humidity		-25 to 55oC / 35 to 85% RH			
Materials		ABS(Case), PMMA(Lens)			

*M8-QD in 3 pins for European machines " are available with extension code of -CN(P)3, for instance, "ZR-QX200CN3".

*1 white paper 100 X 100mm

Circuit diagram

NPN output

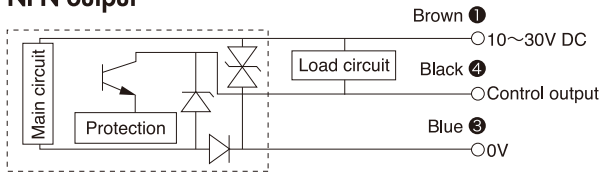

Emitter of Thru-beam type

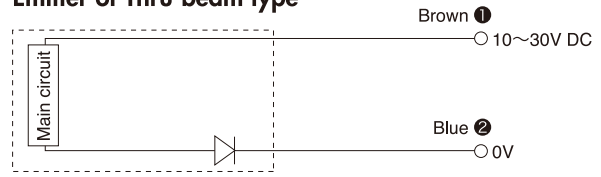

PNP output

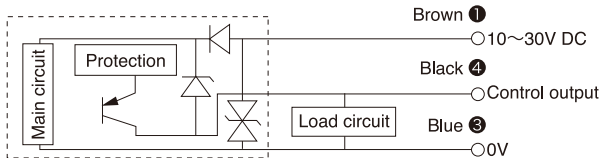

Dimensions

General Use Type except BGS

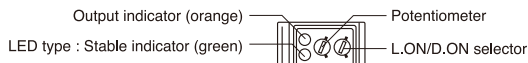

Remark : ZR-QX type (coaxial beam for transparent detection) has single LED (orange for output indicator).

BGS Type

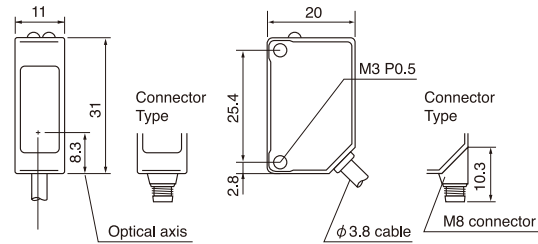
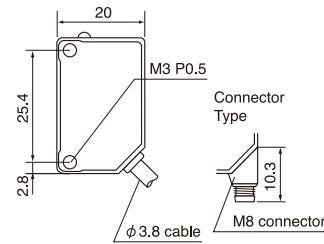
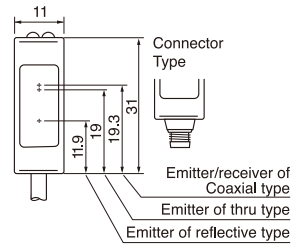
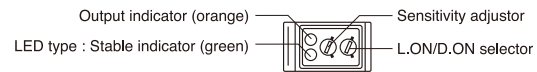

<Cable>

- Brown : DC10~30V
- Blue : GND
- Black : Control Output
- Gray : Laser OFF (Laser type only)
- (NPN connect to GND / PNP connect to DC10~30V)

<3 Pin configuration>



<4 Pin configuration>

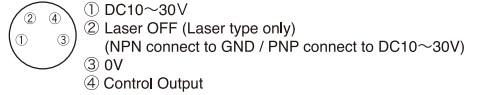

Standard bracket BEF-W100-A

Accessory for M8 QD type sensors

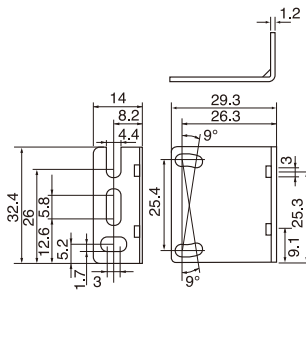

Standard bracket BEF-W100-B

Accessory for cabled type sensors

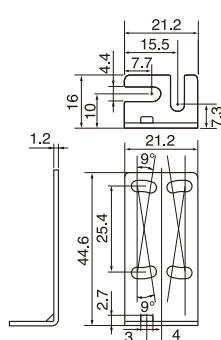

Slit mask BL-160-SK

(for Thru-beam type)

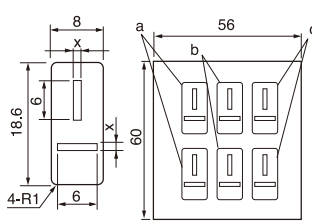

Type	Size	Attached to	Object size (Min)	Scanning range
Slit a	0.5mm	Receiver, Emitter	0.4mm	0.8mm
Slit b	1mm	Receiver, Emitter	0.6mm	2.5mm
Slit c	2mm	Receiver, Emitter	1.5mm	5mm

Metal (SUS) Slit mask BL-100-M1

(for Thru-Beam Type)

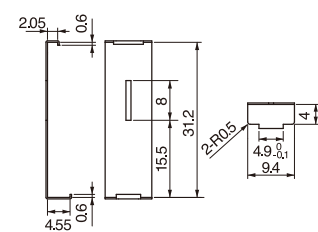

(Unit : mm)

Reflectors for LED Type

Standard reflector V-61
(Standard, LED type)

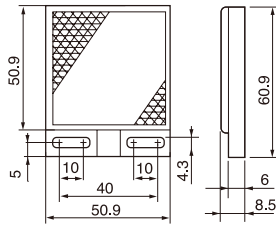

Small reflector V-42
(Optional, LED type)

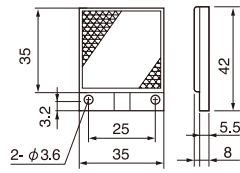

Tiny reflector P45A
(Optional, LED type)

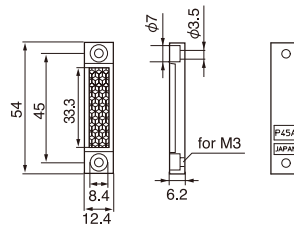

Reflectors for Coaxial LED Type

P250F
(Standard, ZR-QX200)

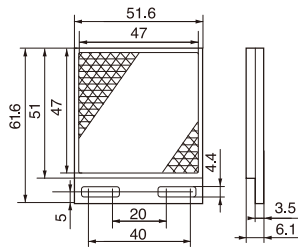

PL20F
(Optional)

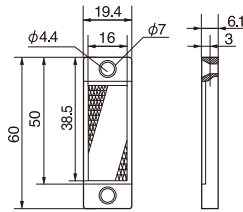

PL10F
(Optional)

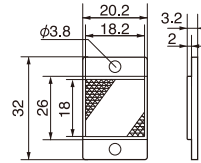

Detection distance by reflectors

	P250F	PL20F	PL10F
ZR-QX	4.0	2.8	1.0

(Unit : meter)

Options

Standard reflector V-61
(Except ZR-QX200)



Small reflector V-42



Tiny reflector P45A



P250F (ZR-QX200, standard)



PL20F (Optional)



PL10F (Optional)



JCN-S : M8 Straight type



JCN-S : 2 meter
JCN-5S : 5 meter
JCN-10S : 10 meter

JCN-L : L-shape M8 type



JCN-L : 2 meter
JCN-5L : 5 meter
JCN-10L : 10 meter

Protective mounting brackets
LK-S01 LK-S02



BL-100-POLF: Cross-talk prevention filter for ZT-1200



Z
BCS-Z

Z2

Z3

ZM

K

BGS-2S

Y

DM-18T

Accessory

Reference (typical)

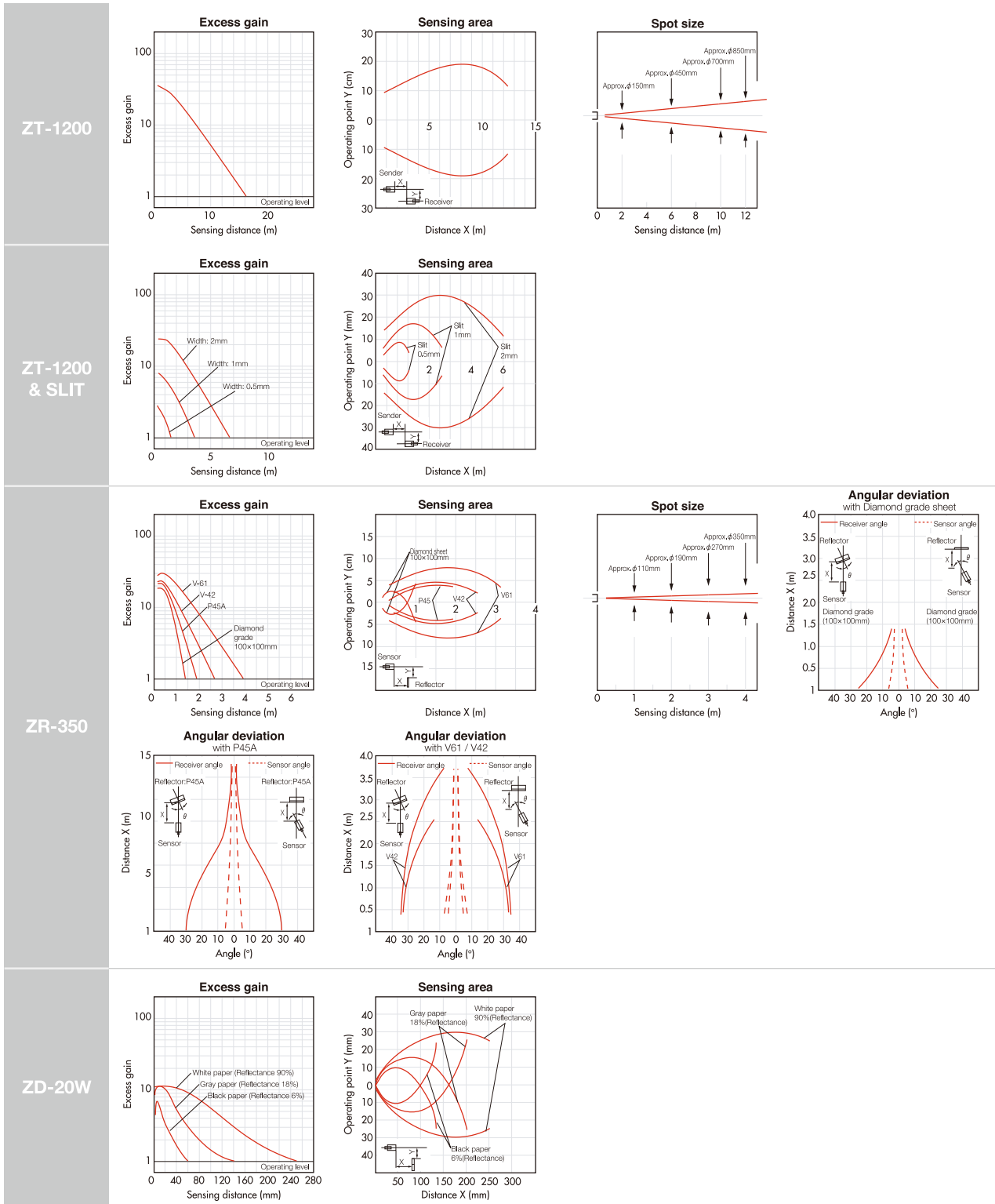

- C
- C2
- E
- J
- J2
- J3
- V
- V2
- V3
- V4
- SR-Q
- S
- Z**
- BGS-Z
- Z2
- Z3
- ZM
- K
- BGS-2S
- Y
- DM-18T
- Accessory

Reference (typical)

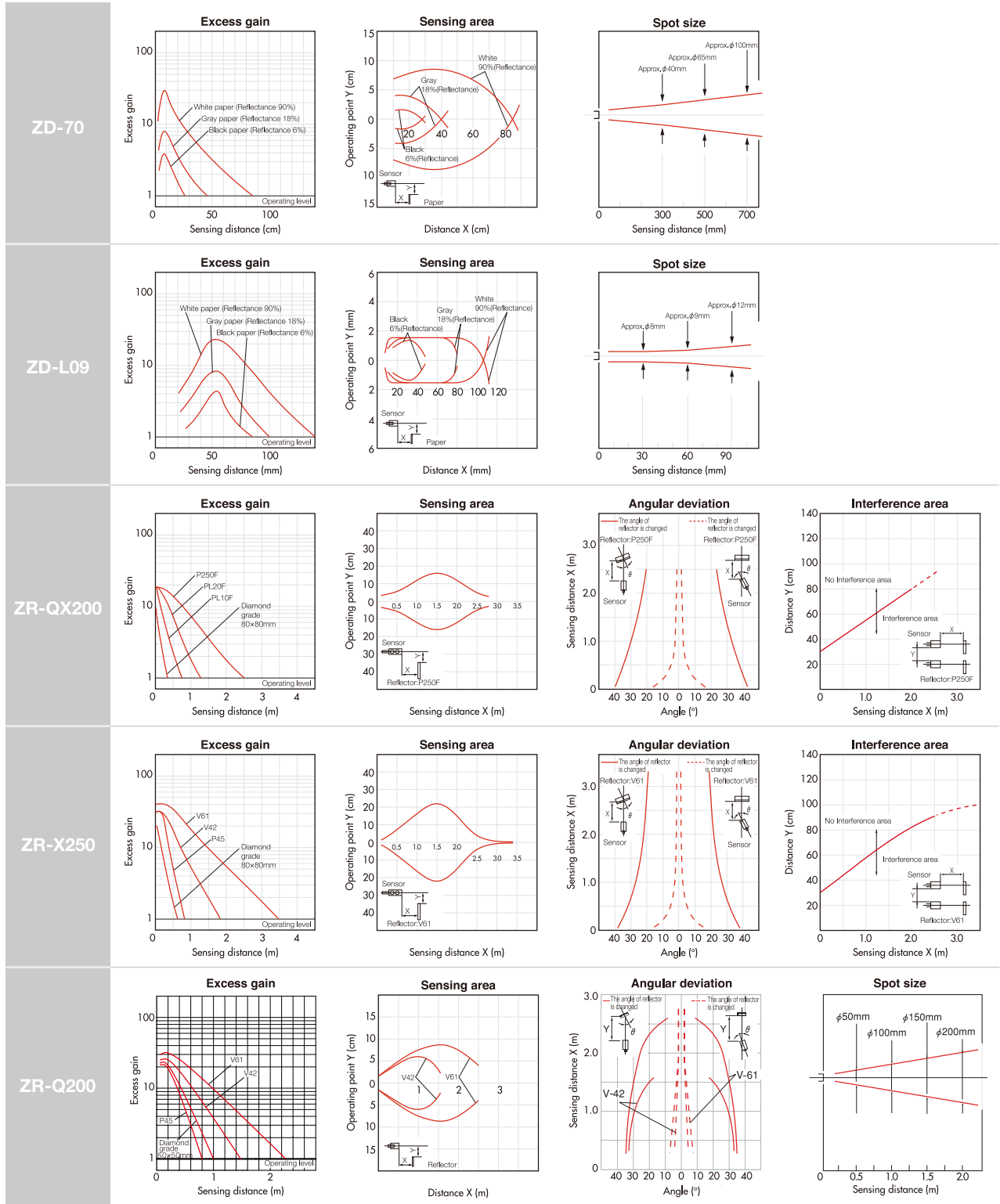

Reference (typical)

BGS-Z30

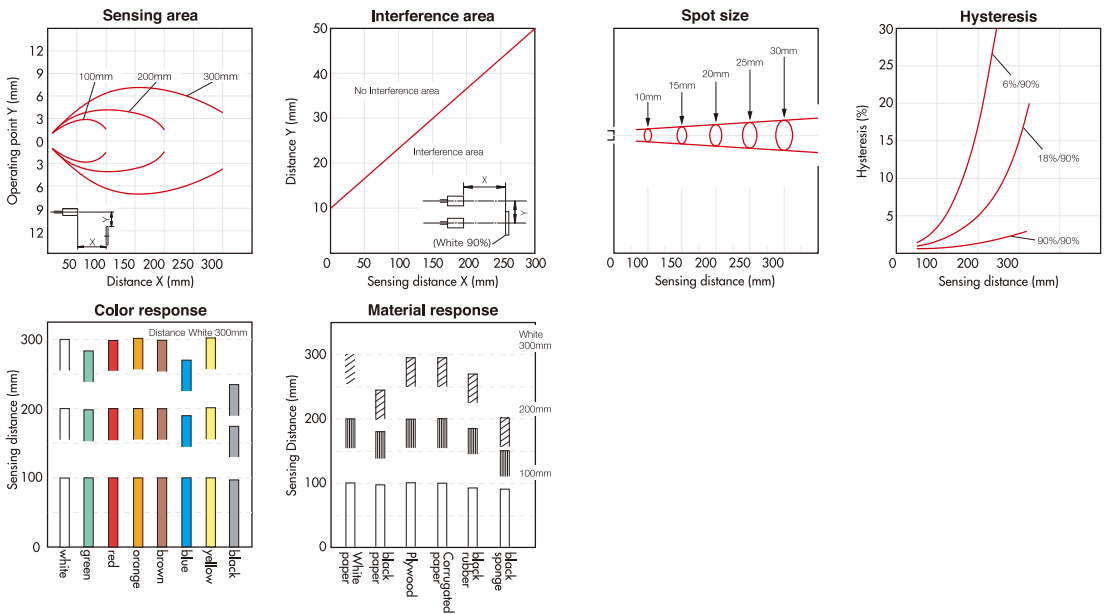

BGS-Z10

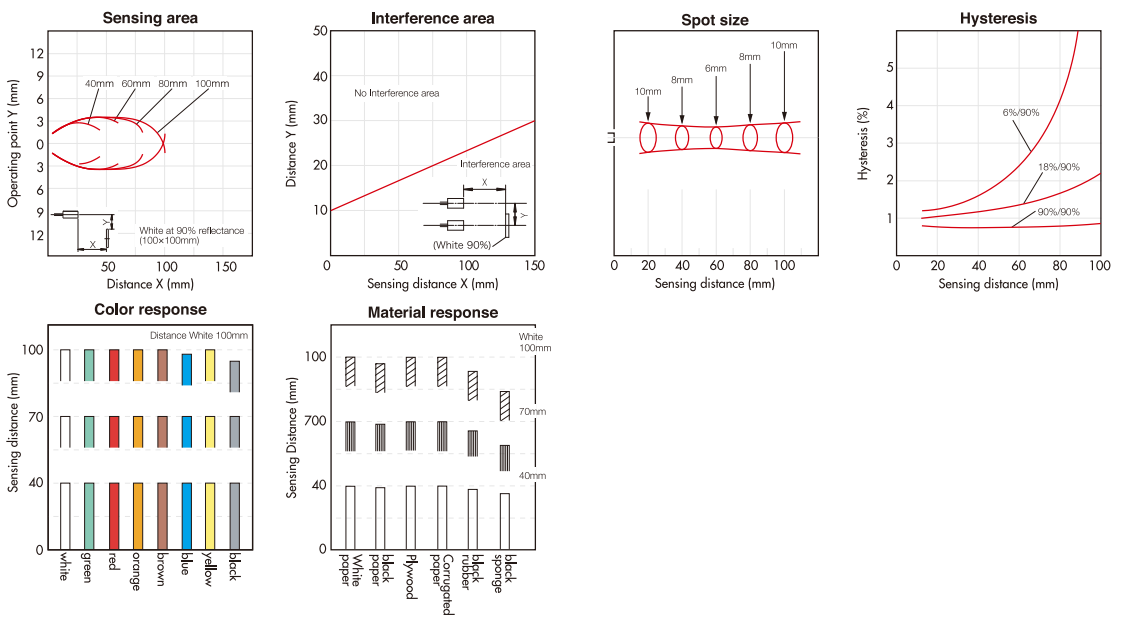

- C
- C2
- E
- J
- J2
- J3
- V
- V2
- V3
- V4
- SR-Q
- S
- Z**
- BGS-Z
- Z2
- Z3
- ZM
- K
- BGS-2S
- Y
- DM-18T
- Accessory