

FEATURES

- Good resistance to corrosive elements (barrel and stainless steel rod)

GENERAL

Detection	Equipped or not for magnetic position detectors
Fluid	Air or neutral gas, filtered, lubricated or not
Operating pressure	2 to 10 bar
Ambient temperature	0°C to +70°C (Ø8-10) / -10°C to +70°C (Ø12 to 25)
Standards	ISO 6432 - 8140 - 8139 CETOP RP 52 P - RP 102 P - RP 103 P AFNOR NF E 49-030

Minimum pressure to compress the spring : 2 bar
The return of the piston rod must be without load

CONSTRUCTION

	Cylinder non-equipped for detectors	Cylinder equipped for detectors
Barrel	Stainless steel	Non-magnetic stainless steel
Rod	Stainless steel	Stainless steel
Front and rear covers	Anodized light alloy	Anodized light alloy
Piston	POM (polyacetal) and light alloy	POM (polyacetal) and light alloy equipped with permanent magnet
Piston seals	PUR (polyurethane)	PUR (polyurethane)
Neck nut	Galvanized steel	Galvanized steel
Rod nut	Galvanized steel	Galvanized steel
Dismounting	Cannot be dismounted	Cannot be dismounted
Cushioning	Without cushioning	Without cushioning

SPECIFICATIONS

Ø (mm)	stroke (mm)	rod returned at rest (SER)		rod out at rest (SES)		connection Ø
		catalogue number	reference	catalogue number	reference	
Cylinder non-equipped for detectors						
8	25	43500254	C 8 AS 25 - SER	-	-	M5
	50	43500255	C 8 AS 50 - SER	-	-	
10	25	43500256	C 10 AS 25 - SER	-	-	M5
	50	43500257	C 10 AS 50 - SER	-	-	
12	25	43500083	C 12 AS 25 - SER	43500218	C 12 AS 25 - SES	M5
	50	43500084	C 12 AS 50 - SER	43500219	C 12 AS 50 - SES	
16	25	43500085	C 16 AS 25 - SER	43500220	C 16 AS 25 - SES	M5
	50	43500086	C 16 AS 50 - SER	43500221	C 16 AS 50 - SES	
20	25	43500087	C 20 AS 25 - SER	43500222	C 20 AS 25 - SES	G 1/8
	50	43500088	C 20 AS 50 - SER	43500223	C 20 AS 50 - SES	
25	25	43500089	C 25 AS 25 - SER	43500224	C 25 AS 25 - SES	G 1/8
	50	43500090	C 25 AS 50 - SER	43500225	C 25 AS 50 - SES	
Cylinder equipped for detectors *						
8	25	43500258	C 8 AS 25 - SER/DM	-	-	M5
	50	43500259	C 8 AS 50 - SER/DM	-	-	
10	25	43500260	C 10 AS 25 - SER/DM	-	-	M5
	50	43500261	C 10 AS 50 - SER/DM	-	-	
12	25	43500262	C 12 AS 25 - SER/DM	-	-	M5
	50	43500263	C 12 AS 50 - SER/DM	-	-	
16	25	43500264	C 16 AS 25 - SER/DM	-	-	M5
	50	43500265	C 16 AS 50 - SER/DM	-	-	
20	25	43500266	C 20 AS 25 - SER/DM	-	-	G 1/8
	50	43500267	C 20 AS 50 - SER/DM	-	-	
25	25	43500268	C 25 AS 25 - SER/DM	-	-	G 1/8
	50	43500269	C 25 AS 50 - SER/DM	-	-	

* The magnetic position detectors must be ordered separately: UNI model, reed switch or magneto-resistive type (see page P295) or COMPACT model, reed switch or magneto-resistive type (see page P293)

MOUNTINGS (see page 3)

OPTIONS

- Piston rod in hard chrome steel, catalogue number: **995001** - in 316L stainless steel, catalogue number: **995002** in 303 stainless steel, catalogue number: **995202**
- Overlength piston rod in hard chrome steel, cat. n°: **995003** - in 316L stainless steel, cat. n°: **995004** - in 303 stainless steel, cat. n°: **995204**
- Front through rod in hard chrome steel, cat. n°: **995015** - in 316L stainless steel, cat. n°: **995016** - in 303 stainless steel, cat. n°: **995216** rear through rod in hard chrome steel, cat. n°: **995017** - in 316L stainless steel, cat. n°: **995018** - in 303 stainless steel, cat. n°: **995218**

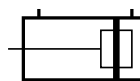

FEATURES

- Good resistance to corrosive elements (barrel and stainless steel rod)

GENERAL

Detection	Equipped or not for magnetic position detectors
Fluid	Air or neutral gas, filtered, lubricated or not
Operating pressure	10 bar max.
Ambient temperature	0°C to +70°C (Ø8-10) / -10°C to +70°C (Ø12 to 25)
Standards	ISO 6432 - 8140 - 8139 CETOP RP 52 P - RP 102 P - RP 103 P AFNOR NF E 49-030



CONSTRUCTION

	Cylinder non-equipped for detectors	Cylinder equipped for detectors
Barrel	Stainless steel	Non-magnetic stainless steel
Rod	Stainless steel	Stainless steel
Front and rear covers	Anodized light alloy	Anodized light alloy
Piston	POM (polyacetal) and light alloy	POM (polyacetal) and light alloy equipped with permanent magnet
Piston seals	PUR (polyurethane)	PUR (polyurethane)
Neck nut	Galvanized steel	Galvanized steel
Rod nut	Galvanized steel	Galvanized steel
Dismounting	Cannot be dismounted	Cannot be dismounted
Cushioning	Without cushioning	Without cushioning

SPECIFICATIONS

Ø (mm)	stroke (mm)	Cylinder non-equipped for detectors		Cylinder equipped for detectors *		connection Ø
		catalogue number	reference	catalogue number	reference	
8	25	43500271	C 8 AS 25	43500291	C 8 AS 25-DM	M5
	50	43500272	C 8 AS 50	43500292	C 8 AS 50-DM	
	80	43500273	C 8 AS 80	43500293	C 8 AS 80-DM	
	100	43500274	C 8 AS 100	43500294	C 8 AS 100-DM	
10	25	43500277	C 10 AS 25	43500296	C 10 AS 25-DM	M5
	50	43500278	C 10 AS 50	43500297	C 10 AS 50-DM	
	80	43500279	C 10 AS 80	43500298	C 10 AS 80-DM	
	100	43500280	C 10 AS 100	43500299	C 10 AS 100-DM	
12	25	43500066	C 12 AS 25	43500301	C 12 AS 25-DM	M5
	50	43500067	C 12 AS 50	43500302	C 12 AS 50-DM	
	80	43500283	C 12 AS 80	43500303	C 12 AS 80-DM	
	100	43500069	C 12 AS 100	43500304	C 12 AS 100-DM	
16	25	43500070	C 16 AS 25	43500305	C 16 AS 25-DM	M5
	50	43500071	C 16 AS 50	43500306	C 16 AS 50-DM	
	80	43500285	C 16 AS 80	43500307	C 16 AS 80-DM	
	100	43500073	C 16 AS 100	43500308	C 16 AS 100-DM	
20	25	43500074	C 20 AS 25	43500309	C 20 AS 25-DM	G 1/8
	50	43500075	C 20 AS 50	43500310	C 20 AS 50-DM	
	80	43500287	C 20 AS 80	43500311	C 20 AS 80-DM	
	100	43500077	C 20 AS 100	43500312	C 20 AS 100-DM	
25	25	43500078	C 25 AS 25	43500313	C 25 AS 25-DM	G 1/8
	50	43500079	C 25 AS 50	43500314	C 25 AS 50-DM	
	80	43500289	C 25 AS 80	43500315	C 25 AS 80-DM	
	100	43500081	C 25 AS 100	43500316	C 25 AS 100-DM	
	160	43500290	C 25 AS 160	43500317	C 25 AS 160-DM	

* The magnetic position detectors must be ordered separately: UNI model, reed switch or magneto-resistive type (see page P295) or COMPACT model, reed switch or magneto-resistive type (see page P293)

MOUNTINGS (see page 3)

OPTIONS

- Other strokes on request
- Double crossbar for Ø 16-20-25 mm (max. stroke 300 mm)
- Barrel in stainless steel for Ø 16-20-25 mm : specify the codes of cylinders equipped for magnetic detectors.
- Anti-corrosive version, stainless steel type CIX (see page P252)
- Piston rod in hard chrome steel, catalogue number: **995001** - in 316L stainless steel, catalogue number: **995002** in 303 stainless steel, catalogue number: **995202**
- Overlength piston rod in hard chrome steel, cat. n°: **995003** - in 316L stainless steel, cat. n°: **995004** - in 303 stainless steel, cat. n°: **995204**
- Front through rod in hard chrome steel, cat. n°: **995015** - in 316L stainless steel, cat. n°: **995016** - in 303 stainless steel, cat. n°: **995216**
rear through rod in hard chrome steel, cat. n°: **995017** - in 316L stainless steel, cat. n°: **995018** - in 303 stainless steel, cat. n°: **995218**

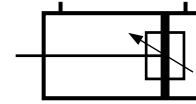

FEATURES

- Good resistance to corrosive elements (barrel and stainless steel rod)

GENERAL

Detection	Equipped or not for magnetic position detectors
Fluid	Air or neutral gas, filtered, lubricated or not
Operating pressure	10 bar max.
Ambient temperature	-10°C to +70°C
Standards	ISO 6432 - 8140 - 8139 CETOP RP 52 P - RP 102 P - RP 103 P AFNOR NF E 49-030

CONSTRUCTION

	Cylinder non-equipped for detectors	Cylinder equipped for detectors
Barrel	Stainless steel	Non-magnetic stainless steel
Rod	Stainless steel	Stainless steel
Front and rear covers	Anodized light alloy	Anodized light alloy
Piston	POM (polyacetal) and light alloy	POM (polyacetal) and light alloy equipped with permanent magnet
Piston seals	PUR (polyurethane)	PUR (polyurethane)
Neck nut	Galvanized steel	Galvanized steel
Rod nut	Galvanized steel	Galvanized steel
Dismounting	Cannot be dismounted	Cannot be dismounted
Cushioning	Pneumatic, adjustable from both sides	Pneumatic, adjustable from both sides



Cushioning length:
Ø 20 mm = 8 mm
Ø 25 mm = 10 mm

SPECIFICATIONS

Ø (mm)	stroke (mm)	Cylinder non-equipped for detectors		Cylinder equipped for detectors *		connection Ø
		catalogue number	reference	catalogue number	reference	
20	25	43500419	C 20 A 25	43500423	C 20 A 25-DM	G 1/8
	50	43500420	C 20 A 50	43500424	C 20 A 50-DM	
	80	43500421	C 20 A 80	43500425	C 20 A 80-DM	
	100	43500422	C 20 A 100	43500426	C 20 A 100-DM	
25	25	43500427	C 25 A 25	43500432	C 25 A 25-DM	G 1/8
	50	43500428	C 25 A 50	43500433	C 25 A 50-DM	
	80	43500429	C 25 A 80	43500434	C 25 A 80-DM	
	100	43500430	C 25 A 100	43500435	C 25 A 100-DM	
	125	43500431	C 25 A 125	43500436	C 25 A 125-DM	
	160	43500431	C 25 A 160	43500436	C 25 A 160-DM	

* The magnetic position detectors must be ordered separately: UNI model, reed switch or magneto-resistive type (see page P295) or COMPACT model, reed switch or magneto-resistive type (see page P293)

MOUNTINGS

Ø (mm)	catalogue number					
	Front or rear flange MF8	High foot (peer unit) MS3	Rear trunnion	Female rod clevis ISO 8140 - RP 102 P AP2	Spherical bearing rod end ISO 8139 - RP 103 P AP6	Neck nut MR3
8	43900189	43900191	43900190	43900193	43900194	43900192
10						
12	43900179	43900183	43900181	43900159	43900186	43900150
16						
20	43900180	43900184	43900182	43900161	43900187	43900151
25				43400016	43400001	

Each cylinder is delivered with a neck nut.

OPTIONS

- Other strokes on request
- Piston rod in hard chrome steel, catalogue number: **995001** - in 316L stainless steel, catalogue number: **995002** in 303 stainless steel, catalogue number: **995202**
- Overlength piston rod in hard chrome steel, cat. n°: **995003** - in 316L stainless steel, cat. n°: **995004** - in 303 stainless steel, cat. n°: **995204**
- Front through rod in hard chrome steel, cat. n°: **995015** - in 316L stainless steel, cat. n°: **995016** - in 303 stainless steel, cat. n°: **995216** rear through rod in hard chrome steel, cat. n°: **995017** - in 316L stainless steel, cat. n°: **995018** - in 303 stainless steel, cat. n°: **995218**

DIMENSIONS (mm), WEIGHT (kg) 

Bare cylinder (delivered with neck nut)

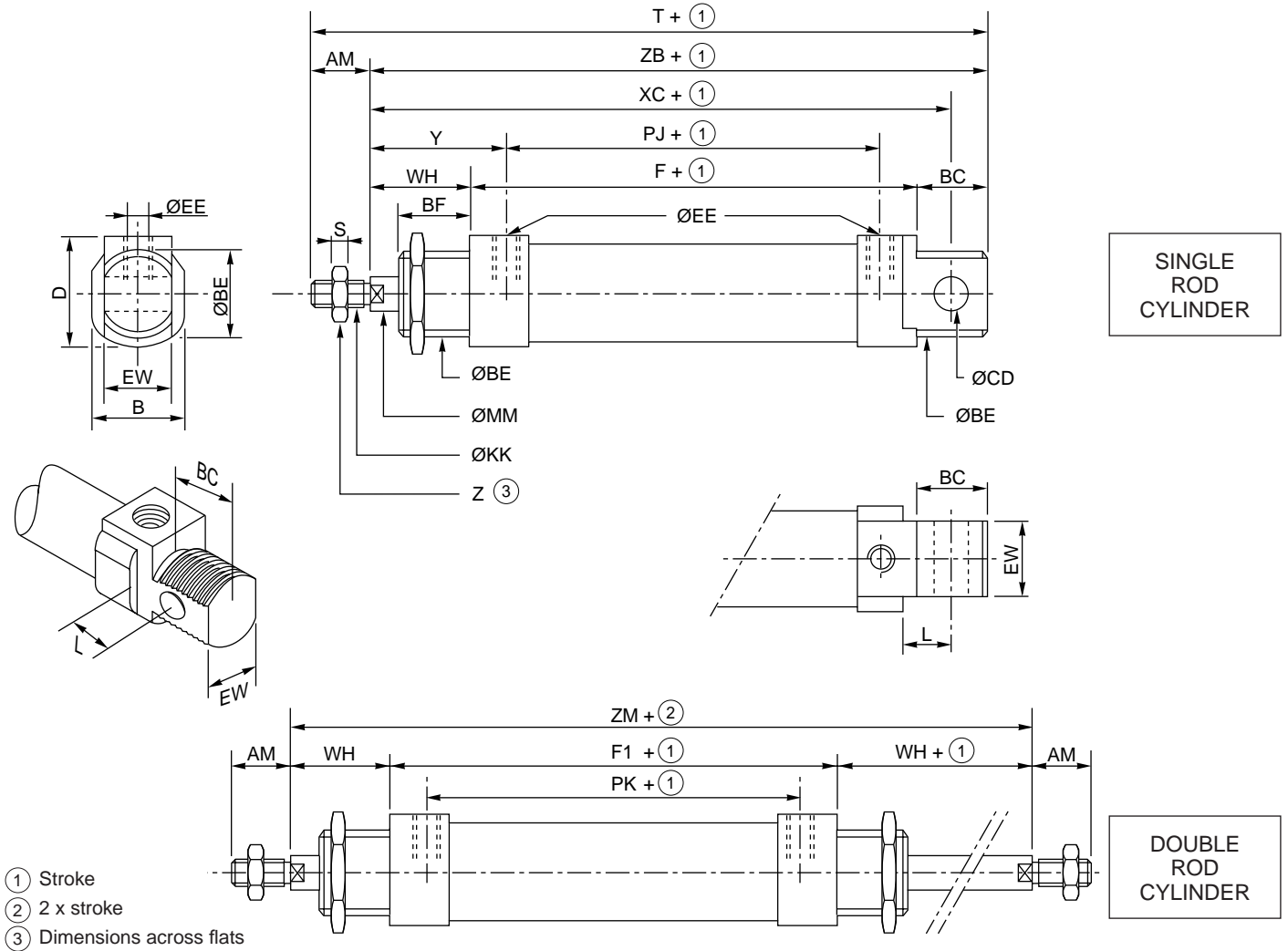

Ø	AM	B	BC	ØBE	BF	CD	D	EE	EW	F	F1	ØKK	L	MM	PJ	PK	S	T	WH
8	12	12	12	M12x1,25	12	4 H 9	18	M5	8 d 13	46	-	M4x0,7	6	4	31	-	2	86	16
10	12	12	12	M12x1,25	12	4 H 9	18	M5	8 d 13	46	-	M4x0,7	6	4	31	-	2	86	16
12	16	16	14	M16x1,5	14	6 H 11	20	M5	12 d 11	48,7	48,7	M6x1	9	6	34,5	34,5	3	100,3	22
16	16	20	14	M16x1,5	14	6 H 11	21	M5	12 d 11	55,7	52,7	M6x1	9	6	41,5	38,5	3	107,3	22
20	20	29	17,5	M22x1,5	17,5	8 H 11	29	G 1/8	16 d 11	64,2	64,2	M8x1,25	12	10	47,3	47,3	4	125,3	24
25	22	29	17,5	M22x1,5	17,5	8 H 11	30	G 1/8	16 d 11	69,5	69,5	M10x1,25	12	10	52,5	52,5	5	136,8	28

Ø	XC	Y	Z	ZB	ZM	weight	
						(4)	(5)
8	64	23,5	7	74	-	0,030	0,020
10	64	23,5	7	74	-	0,030	0,040
12	75	29	10	84,5	93,4	0,070	0,090
16	81,5	29	10	91,5	97,4	0,100	0,100
20	95	32,5	13	103,5	113	0,170	0,160
25	104	36,5	17	115	126,5	0,200	0,200

(4) Cylinder weight with 0 mm stroke.

(5) Weight to be added per additional 100 mm length.

NOTE:

- Single and double acting cylinders Ø 8 to 25 mm have the same dimensions.
- The length of the SES version is **twice** the nominal stroke.
- The mountings are always delivered separately.

DIMENSIONS (mm), WEIGHT (kg) 
Front or rear mounting flange - MF8

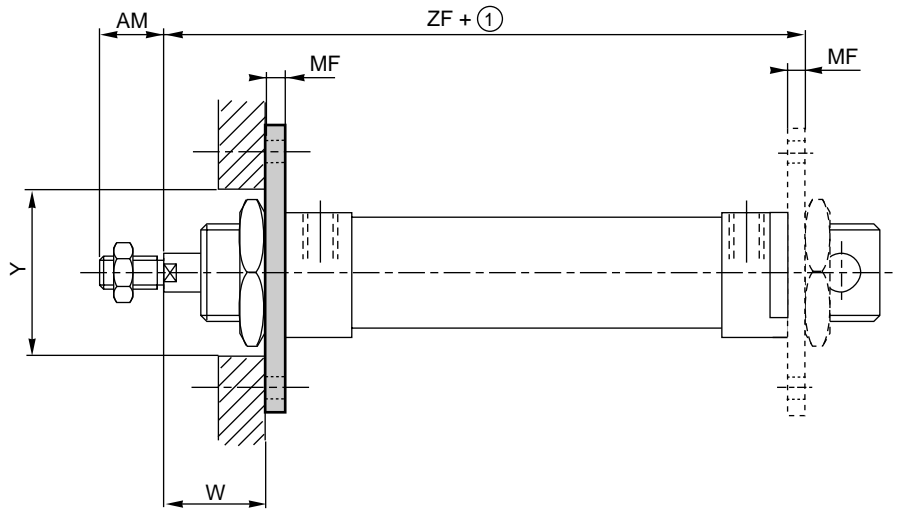
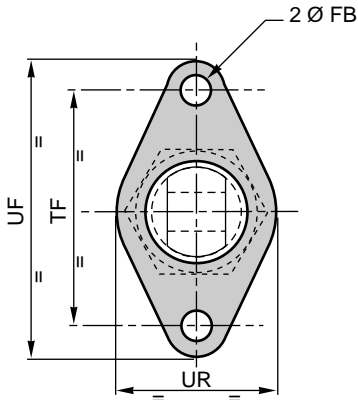

B

High foot mounting - MS3

Foot mountings are supplied in single units, not in pairs.

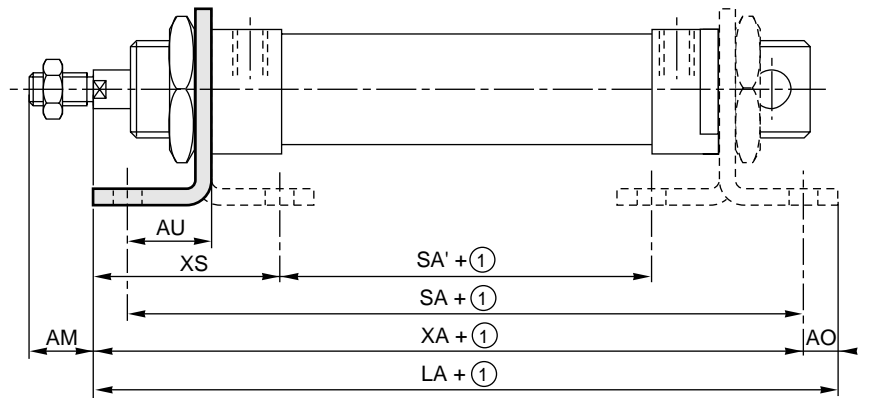
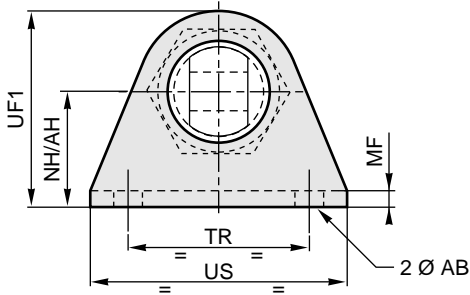

① Stroke

Ø	AM	AO	AU	ØAB ØFB	XA	LA	MF	NH AH	SA	SA'	TF	TR	UR	UF	UF1	US	W	XS	Y	ZF
8	12	5	11	4,5	72	78	3	16	68	30	30	25	22	40	26	35	13	24	22	65
10	12	5	11	4,5	72	78	3	16	68	30	30	25	22	40	26	35	13	24	22	65
12	16	6	14	5,5	84	90	4	20	76	28	40	32	30	52	32	42	18	32	22	74
16	16	6	14	5,5	90,5	96,5	4	20	82,5	34,5	40	32	30	52	32	42	18	32	22	80,5
20	20	9	17	6,6	104,5	113,5	5	25	97,5	39,5	50	40	40	64	45	54	19	36	31	92,5
25	22	9	17	6,6	113,5	122,5	5	25	102,5	44,5	50	40	40	64	45	54	23	40	31	101,5

Ø	weight	
	front or rear flange	foot
8	0,020	0,030
10	0,020	0,030
12	0,020	0,050

Ø	weight	
	front or rear flange	foot
16	0,020	0,050
20	0,040	0,100
25	0,040	0,100

DIMENSIONS (mm), WEIGHT (kg) 

Rear trunnion mounting

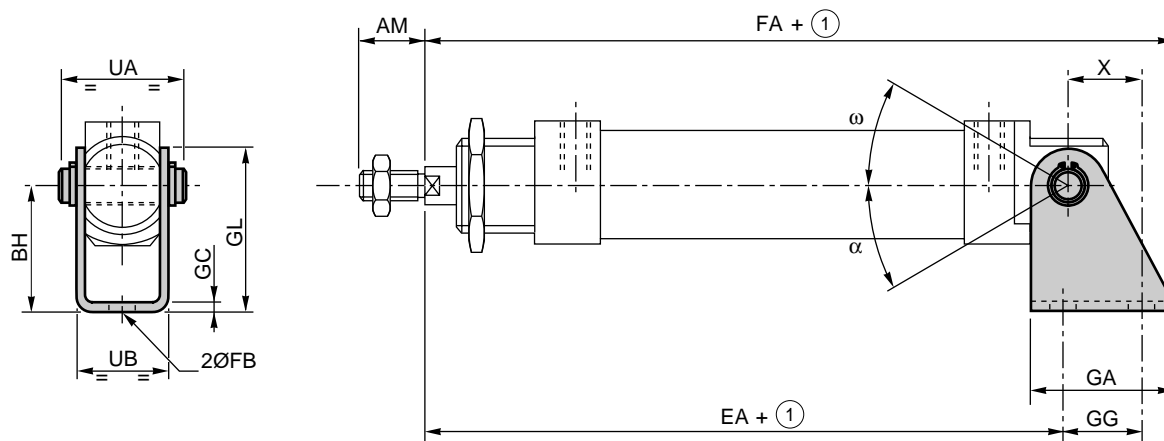

① Stroke

Ø	AM	BH	EA	FA	FB	GA	GC	GG	GL	UA	UB	X	α	ω
8	12	24	62,7	79	4,5	20	2,5	12,5	29	18	13	11,2	7°	160°
10	12	24	62,7	79	4,5	20	2,5	12,5	29	18	13	11,2	7°	160°
12	16	27	72,5	93	5,5	25	3	16	34	25	18	13,5	50°	180°
16	16	27	79	99,5	5,5	25	3	16	34	25	18	13,5	47°	180°
20	20	30	91	117	6,6	32	4	20	40	32	24	16	8°	168°
25	22	30	100	126	6,6	32	4	20	40	32	24	16	8°	168°

Ø	weight rear trunnion
8	0,020
10	0,020
12	0,050

Ø	weight rear trunnion
16	0,050
20	0,080
25	0,080

DIMENSIONS (mm), WEIGHT (kg)

Female rod clevis - AP2

ISO 8140 - RP 102 P

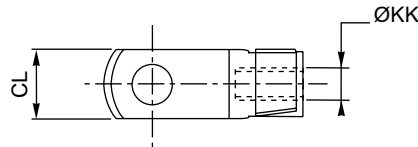
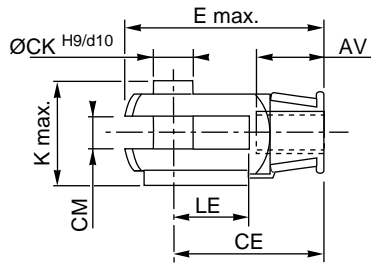

Spherical bearing rod end - AP6

ISO 8139 - RP 103 P

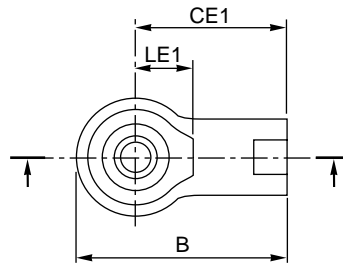
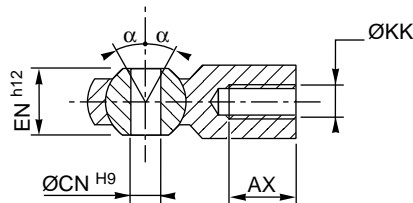

Neck nut - MR3

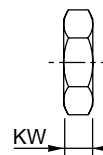
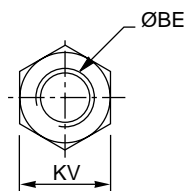

Ø	AV - AX	B	ØBE	CE	CE1	ØCK	CL	CM	ØCN	E	EN	K	ØKK	KV	KW	LE	LE1	α
8	8	36	M12x1,25	16	27	4	8	4 ^{+0,4} _{+0,1}	5	22,5	8	11	M4x0,7	19	6	8	10	4°
10	8	36	M12x1,25	16	27	4	8	4 ^{+0,4} _{+0,1}	5	22,5	8	11	M4x0,7	19	6	8	10	4°
12	12	40	M16x1,5	24	30	6	12	6 ^{+0,4} _{+0,1}	6	33,5	9	16,5	M6x1	19	4	12	11	4°
16	12	40	M16x1,5	24	30	6	12	6 ^{+0,4} _{+0,1}	6	33,5	9	16,5	M6x1	19	4	12	11	4°
20	15	48	M22x1,5	32	36	8	16	8 ^{+0,5} _{+0,15}	8	45	12	22	M8x1,25	27	5	16	13	4°
25	20	57	M22x1,5	40	43	10	20	10 ^{+0,5} _{+0,15}	10	56	14	26	M10x1,25	27	5	20	15	4°

Ø	weight		
	female clevis	male clevis	nut
8	0,010	0,020	0,010
10	0,010	0,020	0,010
12	0,020	0,030	0,010

Ø	weight		
	female clevis	male clevis	nut
16	0,020	0,030	0,010
20	0,050	0,050	0,010
25	0,100	0,070	0,010